



**55US772M0UC**  
**65US772M0UC**

## **Hospital Grade Interactive Pro:Centric<sup>®</sup> TVs**

---

# **Commercial Mode Setup Guide**

Note: Selected features shown in this guide may not be available on all models.

### **EXPERIENCED INSTALLER**

First Use Wizard  
pages 19–21

Custom Master TV Setup  
pages 75–78

Cloning Procedures  
pages 79–85

For Customer Support/Service, please call:

**1-888-865-3026**

The latest product information and documentation is available online at:

**www.lg.com/us/business**

MODEL and SERIAL NUMBER

The model and serial numbers of this TV are located on the back of the cabinet. For future reference, LG suggests that you record those numbers here:

Model No. \_\_\_\_\_ Serial No. \_\_\_\_\_



**WARNING:**

TO REDUCE THE RISK OF ELECTRIC SHOCK DO NOT REMOVE COVER (OR BACK). NO USER-SERVICEABLE PARTS INSIDE. REFER TO QUALIFIED SERVICE PERSONNEL.



The lightning flash with arrowhead symbol, within an equilateral triangle, is intended to alert the user to the presence of uninsulated “dangerous voltage” within the product’s enclosure that may be of sufficient magnitude to constitute a risk of electric shock to persons.



The exclamation point within an equilateral triangle is intended to alert the user to the presence of important operating and maintenance (servicing) instructions in the literature accompanying the appliance.

**WARNING:**

TO PREVENT FIRE OR SHOCK HAZARDS, DO NOT EXPOSE THIS PRODUCT TO RAIN OR MOISTURE.

**WARNING:**

This product contains chemicals known to the State of California to cause cancer and birth defects or other reproductive harm. ***Wash hands after handling.***

**POWER CORD POLARIZATION:**

This product is equipped with a 3-wire grounding-type alternating current power plug. This plug will fit into the power outlet only one way. This is a safety feature. If you are unable to insert the plug fully into the outlet, contact your electrician to replace your obsolete outlet. Do not defeat the safety purpose of the 3-wire grounding-type plug.

**NOTE TO CABLE/TV INSTALLER:**

This reminder is provided to call the cable TV system installer’s attention to Article 820-40 of the National Electrical Code (U.S.A.). The code provides guidelines for proper grounding and, in particular, specifies that the cable ground shall be connected to the grounding system of the building, as close to the point of the cable entry as practical.

**REGULATORY INFORMATION:**

This equipment has been tested and found to comply with the limits for a Class B digital device, pursuant to Part 15 of the FCC Rules. These limits are designed to provide reasonable protection against harmful interference when the equipment is operated in a residential installation. This equipment generates, uses and can radiate radio frequency energy and, if not installed and used in accordance with the instruction manual, may cause harmful interference to radio communications. However, there is no guarantee that interference will not occur in a particular installation. If this equipment does cause harmful interference to radio or television reception, which can be determined by turning the equipment off and on, the user is encouraged to try to correct the interference by one or more of the following measures:

- Reorient or relocate the receiving antenna.
- Increase the separation between the equipment and receiver.
- Connect the equipment to an outlet on a circuit different from that to which the receiver is connected.
- Consult the dealer or an experienced radio/TV technician for help.

**CAUTION:**

Do not attempt to modify this product in any way without written authorization from LG Electronics U.S.A., Inc. Unauthorized modification could void the user’s authority to operate this product.

**COMPLIANCE:**

The responsible party for this product’s compliance is: LG Electronics U.S.A., Inc.  
1000 Sylvan Avenue, Englewood Cliffs, NJ 07632, USA • Phone: 1-201-816-2000

Marketed and Distributed in the United States by LG Electronics U.S.A., Inc.  
1000 Sylvan Avenue, Englewood Cliffs, NJ 07632

# IMPORTANT SAFETY INSTRUCTIONS

1. Read these instructions.
2. Keep these instructions.
3. Heed all warnings.
4. Follow all instructions.
5. Do not use this apparatus near water.
6. Clean only with dry cloth.
7. Do not block any ventilation openings. Install in accordance with the manufacturer's instructions.
8. Do not install near any heat sources, such as radiators, heat registers, stoves, or other apparatus (including amplifiers) that produce heat.
9. Do not defeat the safety purpose of the polarized or grounding-type plug. A polarized plug has two blades with one wider than the other. A grounding-type plug has two blades and a third grounding prong. The wide blade or the third prong are provided for your safety. If the provided plug does not fit into your outlet, consult an electrician for replacement of the obsolete outlet.
10. Protect the power cord from being walked on or pinched, particularly at plugs, convenience receptacles, and the point where it exits from the apparatus.
11. Only use attachments/accessories specified by the manufacturer.
12. Use only with the cart, stand, tripod, bracket, or table specified by the manufacturer or sold with the apparatus. When a cart is used, use caution when moving the cart/apparatus combination in order to avoid injury from tip-over.



13. Refer all servicing to qualified service personnel. Servicing is required when the apparatus has been damaged in any way, such as power-supply cord or plug is damaged, liquid has been spilled or objects have fallen into the apparatus, the apparatus has been exposed to rain or moisture, does not operate normally, or has been dropped.
14. Never touch this apparatus or antenna during a thunder or lightning storm.
15. Do not apply pressure on or scratch the TV panel during handling. Do not press against the TV panel with your hand or a sharp object such as a nail, pencil, or pen.

## 16. Power Cord

**Caution: Check the TV specifications in the Owner's Manual to determine power requirements.**

Periodically examine the cord of your appliance, and if its appearance indicates damage or deterioration, unplug it, discontinue use of the appliance, and have the cord replaced with an exact replacement part by an authorized servicer. Protect the power cord from physical or mechanical abuse, such as twisting, kinking, or pinching or being closed in a door or walked upon. Pay particular attention to plugs, wall outlets, and the point where the cord exits the appliance.

Do not use a damaged or loose power cord. Be sure to grasp the plug when unplugging the power cord. Do not pull on the power cord to unplug the TV.

Do not stick metal objects or any other conductive material into the power cord. Do not touch the end of the power cord while it is plugged in.

## 17. Overloading

Do not connect too many appliances to the same AC power outlet as this could result in fire or electric shock. Do not overload wall outlets. Overloaded wall outlets, loose or damaged wall outlets, extension cords, frayed power cords, or damaged or cracked wire insulation are dangerous. Any of these conditions could result in fire or electric shock.

## 18. Outdoor Use/Wet Location



**Warning: To reduce the risk of fire or electrical shock, do not expose this product to rain, moisture or other liquids.**

Do not touch the TV with wet hands. Do not install this product near flammable objects such as gasoline or candles or expose the TV to direct air conditioning.

Do not expose to dripping or splashing and do not place objects filled with liquids, such as vases, cups, etc., on or over the apparatus (e.g., on shelves above the unit).

## 19. Grounding

(Except for devices that are not grounded) Ensure that you connect the earth ground wire to prevent possible electric shock (i.e., a TV with a three-prong grounded AC plug must be connected to a three-prong grounded AC outlet). If grounding methods are not possible, have a qualified electrician install a separate circuit breaker. Do not try to ground the unit by connecting it to telephone wires, lightning rods, or gas pipes.

## 20. Disconnect Device

The power plug is the disconnecting device. The power plug must remain readily accessible.

As long as this unit is connected to the AC wall outlet, it is not disconnected from the AC power source even if the unit is turned off.

(Continued on next page)

# IMPORTANT SAFETY INSTRUCTIONS

(Continued from previous page)

## 21. Outdoor Antenna Grounding

If an outside antenna or cable system is connected to the product, follow the precautions below.

An outdoor antenna system should not be located in the vicinity of overhead power lines or other electric light or power circuits or where it can come into contact with such power lines or circuits as death or serious injury can occur.

Be sure the antenna system is grounded so as to provide some protection against voltage surges and built-up static charges.

Article 810 of the National Electrical Code (NEC) in the U.S.A. provides information with respect to proper grounding of the mast and supporting structure, grounding of the lead-in wire to an antenna-discharge unit, size of grounding conductors, location of antenna-discharge unit, connection to grounding electrodes, and requirements for the grounding electrode.

### Antenna Grounding According to NEC, ANSI/NFPA 70

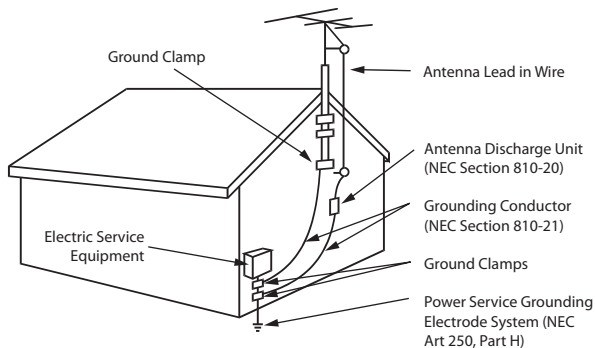

## 22. Cleaning

When cleaning, unplug the power cord and wipe gently with a soft cloth to prevent scratching. Do not spray water or other liquids directly on the TV as electric shock may occur. Do not clean with chemicals such as alcohol, thinners or benzene.

## 23. Transporting Product

Make sure the TV is turned off and unplugged and that all cables have been removed. It may take two or more people to carry larger TVs. Do not press against or put stress on the front panel of the TV.

## 24. Ventilation

Install the TV where there is proper ventilation. Do not install in a confined space such as a bookcase. Do not cover the TV with cloth or other materials (e.g., plastic) while it is plugged in. Do not install in excessively dusty places.

25. If you smell smoke or other odors coming from the TV or hear strange sounds, unplug the power cord, and contact an authorized service center.

26. Keep the product away from direct sunlight.

27. When mounting a TV on the wall, make sure that none of the electrical cabling bears any of the weight of the TV. Install in accordance with the manufacturer's instructions.

28. Do not install this product on a wall if it could be exposed to oil or oil mist. This may damage the product and cause it to fall.

29. Do not allow an impact shock or any objects to fall into the product, and do not drop objects onto the screen.

30. Do not touch the ventilation openings, as they may become hot while the TV is operating. This does not affect the performance of the product or cause defects in the product.

31. Do not use high voltage electrical equipment near the TV (e.g., a bug zapper). This may result in product malfunction.

## 32. Dot Defect

This panel is an advanced product that contains millions of pixels. In a very few cases, you could see fine dots on the screen while you are viewing the TV. Those dots are deactivated pixels and do not affect the performance and reliability of the TV.

## 33. Generated Sound

“Cracking”: A cracking noise that occurs while the TV is on or when it is turned off is generated by plastic thermal contraction due to temperature and humidity. This noise is common for products where thermal deformation is required.

Electrical circuit humming/panel buzzing: A low level noise is generated from a high-speed switching circuit, which supplies a large amount of current to operate a product. It varies depending on the product. This generated sound does not affect the performance and reliability of the product.

34. If the TV feels cold to the touch, there may be a small “flicker” when it is turned on. This is normal; there is nothing wrong with the TV. Some minute dot defects may be visible on the screen, appearing as tiny red, green, or blue spots. However, they have no adverse effect on the TV's performance. Avoid touching the screen or holding your finger(s) against it for long periods of time. Doing so may produce some temporary distortion effects on the screen.

35. Displaying a still image for a prolonged period of time may cause image burn-in. Avoid displaying a fixed image on the TV screen for an extended length of time.

# Table of Contents

---

Safety Warnings . . . . .	2	Accessing and Using the Ez Download Utility . . . . .	57
Important Safety Instructions . . . . .	3–4	<b>Installer Menu</b> . . . . .	61–74
Table of Contents . . . . .	5–6	Accessing the Installer Menu . . . . .	61
<b>Commercial Mode Overview</b> . . . . .	7–13	Navigating Within the Installer Menu . . . . .	62
Setup Checklist . . . . .	7	Modifying Installer Menu Settings . . . . .	62
Pass-through Mode . . . . .	7	Exiting the Installer Menu and Activating Settings . . . . .	62
FTG Mode . . . . .	9	Detailed Descriptions of Installer Menu Items . . . . .	65
Application Tuning Mode / Pro:Centric Direct . . . . .	11	<b>Custom Master TV Setup</b> . . . . .	75–78
Determining the TV Operating Mode . . . . .	13	Before You Begin . . . . .	75
<b>Pro:Centric Operation</b> . . . . .	14–18	Clonable TV Setup Menu Features . . . . .	75
Interactive Menu Features . . . . .	14	Custom Master TV Setup Procedure . . . . .	76
Interactive Menu Navigation . . . . .	14	<b>Cloning Procedures</b> . . . . .	79–85
Pro:Centric Java Application Setup . . . . .	16	Exporting a Clone File . . . . .	79
Pro:Centric Direct HTML Application Setup . . . . .	17	Importing a Clone File . . . . .	82
<b>First Use Wizard</b> . . . . .	19–21	<b>Cloud Configuration Tool Overview</b> . . . . .	86–92
Before You Begin . . . . .	19	Creating an FTG Configuration File . . . . .	86
Initiate Configuration or Exit the First Use Wizard . . . . .	20	File Manager Web Page Overview . . . . .	89
<b>Basic Settings Wizard</b> . . . . .	22–26	Channel Map Web Page Overview . . . . .	90
<b>Hospital Setup Wizard</b> . . . . .	27–42	Installer Menu Web Page Overview . . . . .	92
Pro:Centric Settings . . . . .	27	<b>IP Environment Setup</b> . . . . .	93–109
Enable/Disable Aux Inputs . . . . .	31	Accessing the IP Environment Menu . . . . .	93
Set Up Hospital Mode Features (Channel Banks/ Zones & Speaker/IR Settings) . . . . .	31	Network Configuration . . . . .	93
Channel Tuning . . . . .	35	Pro:Centric Setup . . . . .	98
Select Channel Banner, Scan Mode, and Power On Settings . . . . .	38	General Options . . . . .	102
Complete the Hospital Settings . . . . .	40	Portal Settings . . . . .	104
Channel Banks Overview . . . . .	40	Media Share Setup . . . . .	107
<b>Advanced Settings / EZ-Manager Wizard</b> . . . . .	43–55	<b>References</b>	
TV Configuration Options . . . . .	43	Updating TV/PTC Software using a USB Memory Device . . . . .	110–111
Zones and Room Number Assignments . . . . .	44	Downloading Images or Icons using a USB Memory Device . . . . .	112–114
Network Settings . . . . .	45	Downloading a Hotel (Hospital) Video using a USB Memory Device . . . . .	115–117
Pro:Centric Settings . . . . .	48	Downloading a Pro:Idiom Media Key using a USB Memory Device . . . . .	118
Standard Pro:Centric Server Configuration . . . . .	48	Power Consumption Settings . . . . .	119
Pro:Centric Cloud Server Configuration . . . . .	53	TV Aux Input Configuration . . . . .	120
USB Configuration . . . . .	54	b-LAN Setup & Overview . . . . .	121
<b>Ez Download Utility</b> . . . . .	56–60		
Before You Begin . . . . .	56		

---

## Notes

- Installer Menu content is intended for use primarily by qualified TV installation technicians.
- Refer to the applicable Owner's Manual and/or Easy Setup Guide for additional information on TV installation, specifications, maintenance, and safety instructions.
- Design and specifications subject to change without prior notice. This document provides examples of typical TV displays. Your displays may vary from those shown in this document.

# Table of Contents (Cont.)

---

FTG Mode via EBL (Local Configuration) . . . . .	122–123
Auto Input(s) Sensing Feature . . . . .	124–125
US772M Hospital Operations . . . . .	126–127
Restoring Factory Defaults on the TV(s) . . . . .	128
Using the TV's Zoning Features . . . . .	129–132
Using Media Share Features . . . . .	133–135
US772M Rear and Side Jack Panels . . . . .	136
Installer Remote Control Typical Key Functions . . . . .	137
LG Pro:Centric Patient Remote and Pillow Speaker . . . . .	138–141
Pillow Speaker Setup . . . . .	142–143
VESA Standard TV Mounts . . . . .	144
TLT Communication Parameters . . . . .	145–151
Troubleshooting . . . . .	152–154
General Troubleshooting . . . . .	152
General Troubleshooting (Cont.) / Commercial Mode Check / . . . . .	153
FTG Operation Troubleshooting / Channel Banks Setup Troubleshooting . . . . .	154
Glossary of Terms . . . . .	155
Document Revision History / Open Source Software Notice . . . . .	156
Back Cover . . . . .	157

This document describes how to set up US772M Pro:Centric® TVs for Commercial Mode operation. LG commercial TV functionality is based on “ownership” of the Channel Map; that is, the Channel Map resides in the TV’s CPU, Protocol Translation Controller (PTC), or embedded *b*-LAN™ (EBL) module, or it resides in a Pro:Centric application or an external device from the solution provider.

These TV models support several different operational modes: LG’s Free-To-Guest (FTG) Mode via the TV CPU, FTG Mode via the TV’s EBL module, Application Tuning Mode (ATM) with Pro:Centric application, or Pass-through Mode (default). In several operational modes (Pass-through, FTG Mode via CPU, and Application Tuning Mode), these TV models may also be externally controlled via Multiple Protocol Interface (MPI) or TV-Link Tuner (TLT) interface (RS-232C).\*

## Setup Checklist

**Note:** This document provides information specific to Commercial Mode operation. Refer to the Owner’s Manual and/or Easy Setup Guide for information on TV installation and hardware and cable connections.

### Installation

- \_\_\_ Unpack TV and all accessories.
  - \_\_\_ Install batteries in the Installer Remote.
  - \_\_\_ Install TV on VESA mount or stand.
- Note:** It may be advisable to make all cable connections before installing on VESA mount or stand, as appropriate.

### Cable Connections

- \_\_\_ Make all rear jack panel connections, as appropriate.

### Commercial Mode Setup

- \_\_\_ Complete appropriate procedures as described in this document for Commercial Mode operation.

### Hardware Connections

- \_\_\_ Install any additional hardware as appropriate to your institution, LAN, etc.

## Pass-through Mode

This mode allows you to configure individual TVs for Pro:Centric and/or FTG Mode via CPU operation. This mode also allows external control via either the TV’s GAME CONTROL/MPI port or TLT (RS-232C Control) port.

There are several methods for configuring individual TVs that are currently in Pass-through Mode: using one of the First Use Wizard options or using the Custom Master TV Setup procedure.

### First Use Wizard

When the TV is in a factory default state, the First Use Wizard provides four guided setup options:

- Basic Settings: Configuration of basic settings, including language & location, network settings, etc.
- Hospital Setup Wizard: Streamlined configuration of the TV for FTG Mode via CPU with Hospital Mode features.
- Advanced Settings (default): EZ-Manager Wizard configuration for Pro:Centric operation.
- IP Environment Settings: Configuration of network settings, manual Pro:Centric settings, etc. via the IP Environment Menu.

See “First Use Wizard” on pages 19 to 21 for further information.

\* MPI is an LG proprietary control protocol; you will need to sign a non-disclosure agreement (NDA) in order to obtain the MPI interface, timing, and syntactical command set specification.



# Commercial Mode Overview (Cont.)

## Custom Master TV Setup

The Custom Master TV Setup procedure enables you to create a customized Master TV Setup for Pass-through Mode or FTG Mode via CPU configuration purposes. Use the Installer Remote to configure Installer Menu items as required for TV operation and set up TV features (Channels, Picture, Sound, etc.). See “Custom Master TV Setup” on pages 75 to 78 for detailed information.

### Installer Menu

To create a Master TV Setup, you will need to know how to access the commercial controller (PTC) Installer Menu and make changes to the default values as required. If necessary, familiarize yourself with the Installer Menu and how to make and save changes. See pages 61 to 74 for information on accessing the Installer Menu and for detailed descriptions of the Installer Menu items. See also example below.

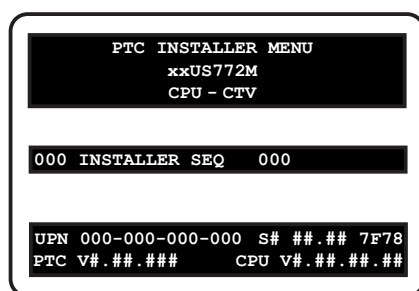

### TV Setup Menus

On-screen setup menus control the features of the TV. Use the Installer Remote to access the TV setup menus, and set the TV features to the desired configuration for the end user. See examples below.

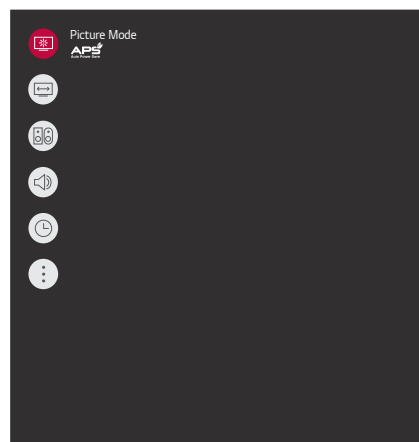

TV Setup Menus (Quick Settings)

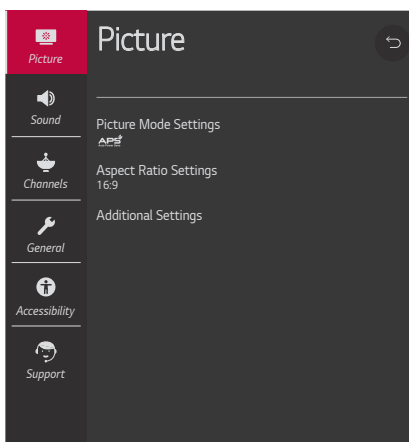

TV Setup Menus (Advanced Settings)



### Cloning

Cloning refers to the process of using a Master TV Setup to configure a Target TV. The Master TV's clonable setup menu features should be configured as part of the Master TV Setup. If there are features in the Master TV's setup—channel icons or labels, digital font options, etc.—that are not set or that are set incorrectly, those features also will not be set or will be set incorrectly in the Target TVs. See pages 79 to 85 for detailed information on Clone (.tlx) files and cloning requirements and procedures.

### External Control

Installer Menu item 030 EXTCTL/ACKMASK determines the availability of external control in accordance with the mode in which the TV is currently operating. See bullets below as well as Installer Menu item 030 description on page 69 for details.

- To control the TV using an external MPI control device, you must use the TV's GAME CONTROL/MPI port for communication purposes. In these TVs, Installer Menu item 118 POWER SAVINGS controls the power circuitry for both the embedded *b*-LAN module and the GAME CONTROL/MPI port; therefore, to ensure that the GAME CONTROL/MPI port circuitry is powered, thus enabling MPI communication, Installer Menu item 118 POWER SAVINGS must be set appropriately. See Installer Menu item 118 description on page 73 as well as Reference section, "*b*-LAN Setup & Overview," for further information.

**Note:** When the TV is in Pass-through/CPU-CTV Mode, item 030 is set to 0 or 1, and an MPI device functioning in "loop" mode is connected to the TV, the TV will go into MPI-EXT Mode, and TLT external control automatically will be blocked.

- To control the TV using an external TLT control device, you must use the TV's RS-232C port for communication purposes. See Reference section, "TLT Communication Parameters," for further information.

### FTG Mode

In this mode, an FTG Channel Map enables the decryption of each Pro:Idiom<sup>®</sup> encrypted channel. The FTG Channel Map also provides logical channel mapping of physical RF channels (digital and analog), IP streams, and Aux inputs. The method for creating the FTG Channel Map is ultimately determined by which element of the TV will "own" the FTG Channel Map—the CPU or the EBL.

For these TV models, there are two FTG Modes—FTG Mode via CPU and FTG Mode via EBL—which are separate and distinct FTG Modes of operation, each with its own unique advantages and requirements, as outlined below. When the TV CPU is configured with an FTG Channel Map, the CPU controls and restricts the tuning operation of the TV, and when the EBL is configured with an FTG Channel Map, the EBL controls and restricts the tuning operation of the TV. In these models, depending on the types of channels included in the FTG Channel Map, FTG Mode via CPU also provides the option to select either logical or physical tuning (see notes at the top of the following page) during configuration. You must determine which element of the TV will own the FTG Channel Map before you can begin configuration.

**Note:** Logical channel mapping of physical RF channels eliminates dash tuning; for example, physical 19-3 can be mapped to logical channel 9. It also allows physical RF channels, IP streams, and Aux inputs to be listed in any order, not only in physical numeric ascending order. Physical channel tuning requires that you include the dash when direct entering RF channel numbers and Aux inputs (the latter designated by 130-0 through 137-0).

**Note:** Physical channel tuning is not available when IP channels are included in the FTG Channel Map.

# Commercial Mode Overview (Cont.)

---

## FTG Mode via CPU

This mode provides the following features:

- Logical or physical channel tuning of physical RF channels and Aux inputs.
- Logical channel tuning of IP streams.
- Mapping of RF channels with minor (program) numbers up to 999.
- FTG Channel Map of up to 600 channels.
- Start Channel set for RF, Aux input, or IP delivered content.
- Pro:Centric data delivery over RF or IP.
- TV Zoning (including channel restrictions by Zone) and Wi-Fi Zoning options for location-specific configurations.
- External control via either the TV's GAME CONTROL/ MPI port or the TV's TLT port (RS-232C Control).

LG's Cloud Configuration Tool enables you to create an FTG Configuration (.tlx) file, which may be used to configure the CPU for FTG Mode. You can also create a Clone (.tlx) file from a Master TV Setup that may be used to configure the CPU for FTG Mode.

**Note:** TV Zoning and Wi-Fi Zoning features are supported via ".tlx" file. See Reference section, "Using the TV's Zoning Features," for further information.

In this mode, the CPU is the owner of the FTG Channel Map and must be configured with an FTG Channel Map and FTG Installer Menu settings using one of the following processes:

- Local: Configure an individual US772M TV via its USB port using a USB memory device / ".tlx" file. The file may be either a Clone file (see "Cloning Procedures" on pages 79 to 85) or an FTG Configuration file (see "Cloud Configuration Tool Overview" on pages 86 to 92).
- Remote: Configure all US772M TVs at the site using a Pro:Centric server head end device (Example: PCS400R). Refer to the **Pro:Centric Server Admin Client User Guide** for further information.

## FTG Mode via EBL

This mode provides the following features:

- Logical channel tuning of physical RF channels and Aux inputs.
- Mapping of RF channels with minor (program) numbers up to 255.
- FTG Channel Map of up to 141 logical channels.
- Start Channel set for RF or Aux input delivered content.
- Pro:Centric data delivery over RF.

LG's FTG Device Configuration Application PC software is required to configure the EBL. In this mode, the EBL is the owner of the FTG Channel Map and must be configured with an FTG Channel Map and FTG Installer Menu settings using one of the following processes:

**Note:** In order to create an FMA Configuration (.fma) file for these models that can be used for remote management of FTG Installer Menu settings, you will need to "Read" FTG Installer Menu settings from a Master TV. See Reference section, "FTG Mode via EBL (Local Configuration)," for further information.

- Local: Configure an individual US772M TV's EBL via its TV-LINK CFG jack using a direct PC-to-TV (EBL) connection and the FTG Device Configuration Application. See Reference section, "FTG Mode via EBL (Local Configuration)," for information on the "Write" process for an FTG Channel Map and FTG Installer Menu settings.
- Remote: Configure all US772M TV EBLs at the site using a Free-To-Guest Management Appliance (FMA) head end device (Example: FMA-LG102). Refer to the **Free-To-Guest (FTG) Device Configuration Application User Guide** and/or the Installation & Configuration Guide for the FMA device for further information.

While the TV is in FTG Mode:

- Users can still access the Installer Menu using an LG Installer Remote; however, all Installer Menu items will be read-only.
- FTG Mode via CPU configuration changes must be made using a “.tlx” file (typically edited in the Cloud Configuration Tool), while FTG Mode via EBL configuration changes must be made using the FTG Device Configuration Application. Channel Map and Installer Menu configuration utilities in both applications enable you to make changes, respectively, to the FTG Channel Map and FTG Installer Menu settings as necessary. Based on the initial method used to configure the TV for FTG Mode operation (via CPU or EBL), all subsequent changes must be transferred to either the TV CPU or the EBL via a process that is in accordance or compatible with that method (see information on local configuration in this document or refer to documentation for the head end device/server for information on remote management).
- If it becomes necessary to restore the TV to Pass-through Mode, there are several options that will enable you to do so. See Reference section, “Restoring Factory Defaults on the TV(s),” for further information.

Pages 86 to 92 provide overviews of the utilities that comprise the Cloud Configuration Tool. Refer to the **Cloud Configuration Tool User Guide** for further information on the Cloud Configuration Tool. Refer to the **Free-To-Guest (FTG) Device Configuration Application User Guide** for information on the FTG Device Configuration Application.

### Remote Management

When the TV is configured for FTG Mode via CPU, remote management of the FTG Channel Map and FTG Installer Menu settings is provided by a Pro:Centric server, via a Clone/Configuration (.tlx) file loaded on the Pro:Centric Admin Client. See the **Pro:Centric Server Admin Client User Guide** for further information.

When the TV is configured for FTG Mode via EBL, the *b*-LAN module, which is internal to the TV, allows hospital/property head end equipment (for example, an FMA-LG102) with *b*-LAN technology to provide remote management of the FTG Channel Map and FTG Installer Menu settings. See Reference section, “*b*-LAN Setup & Overview,” for further information.

### External Control

**Note:** External control in FTG Mode is only available with FTG Mode via CPU.

Installer Menu item 030 EXTCTL/ACKMASK determines the availability of external control in accordance with the mode in which the TV is currently operating. See bullets below as well as Installer Menu item 030 description on page 69 for details. External control is prohibited by default in FTG Mode via CPU. Set item 030 to allow external control via (only) one of the applicable ports.

- To control the TV using an external MPI control device, you must use the TV’s GAME CONTROL/MPI port for communication purposes. In these TVs, Installer Menu item 118 POWER SAVINGS controls the power circuitry for both the embedded *b*-LAN module and the GAME CONTROL/MPI port; therefore, to ensure that the GAME CONTROL/MPI port circuitry is powered, thus enabling MPI communication, Installer Menu item 118 POWER SAVINGS must be set appropriately. See Installer Menu item 118 description on page 73 and/or Reference section, “*b*-LAN Setup & Overview.”
- To control the TV using an external TLT control device, you must use the TV’s RS-232C port for communication purposes. See Reference section, “TLT Communication Parameters,” for further information.

## Commercial Mode Overview (Cont.)

---

### Application Tuning Mode / Pro:Centric Direct

In Application Tuning Mode, the TV's Channel Map resides in an application, such as LG's Pro:Centric Direct HTML application. With Pro:Centric Direct, the Channel Map is created in the Pro:Centric server's Admin Client web editor, and the tuning operation of the TV is controlled and restricted based on this Pro:Centric Direct Channel Map. The Pro:Centric server may be either a standard server installed on-site or a Pro:Centric Cloud (virtual) server hosted on LG's Pro:Centric Cloud portal.

**Note:** The Pro:Centric Cloud portal (applicable only with CPU v4.41.00 or later and PTC v1.00.011 or later) supports Pro:Centric Direct application delivery via Unicast Mode only. Contact your LG service representative for additional information.

Application Tuning Mode with the Pro:Centric Direct HTML application provides the following features:

- Decryption of each Pro:Idiom<sup>®</sup> encrypted channel.
- Logical channel tuning of physical RF channels (digital and analog) and IP streams.
- Mapping of RF channels with minor (program) numbers up to 999.
- Start Channel set for RF or IP delivered content.
- Pro:Centric data delivery over RF (on-site Pro:Centric server only) or IP (on-site Pro:Centric server or Pro:Centric Cloud server).
- TV Zoning (Installer Menu items only) and Wi-Fi Zoning options for location-specific configurations.
- External control via either the TV's GAME CONTROL/MPI port or the TV's TLT port (RS-232C Control).

You must use the Pro:Centric Direct Admin Client / Channel Map configuration utility to create the Pro:Centric Direct Channel Map, define channel attributes, and set the Start Channel. Refer to the ***Pro:Centric Direct Admin Client User Guide*** or the ***Pro:Centric Cloud Admin Client User Guide***, as applicable, for further information.

**Note:** TV Zoning and Wi-Fi Zoning features are supported via ".tlx" file—typically a Clone (.tlx) file that has been created from a Master TV Setup. See Reference section, "Using the TV's Zoning Features," for further information.

While the TV is in Application Tuning Mode:

- Users can still access the Installer Menu using an LG Installer Remote; however, all Installer Menu items will be read-only.
- While it is possible to update a TV's Installer Menu and/or Setup Menu settings locally using a USB memory device / Clone (.tlx) file, any Pro:Centric Direct configuration changes are typically made remotely via the Pro:Centric server / Pro:Centric Direct Admin Client. The Admin Client's Channel Map configuration utility enables you to create and edit the Pro:Centric Direct Channel Map, while the TV Configuration utility (in conjunction with a Clone [.tlx] file loaded on a server carousel) enables you to make changes to TV Installer Menu and/or Setup Menu settings.
- If it becomes necessary to restore the TV to Pass-through Mode, it is possible to do so. See Reference section, "Restoring Factory Defaults on the TV(s)," for further information.

Refer to the ***Pro:Centric Direct Admin Client User Guide*** or the ***Pro:Centric Cloud Admin Client User Guide***, as applicable, for further information on configuration and management via Admin Client.

## External Control

Installer Menu item 030 EXTCTL/ACKMASK determines the availability of external control in accordance with the mode in which the TV is currently operating. See bullets below as well as Installer Menu item 030 description on page 69 for details. External control is prohibited by default in Application Tuning Mode. Set item 030 to allow external control via (only) one of the applicable ports.

- To control the TV using an external MPI control device, you must use the TV's GAME CONTROL/MPI port for communication purposes. In these TVs, Installer Menu item 118 POWER SAVINGS controls the power circuitry for both the embedded *b*-LAN module and the GAME CONTROL/MPI port; therefore, to ensure that the GAME CONTROL/MPI port circuitry is powered, thus enabling MPI communication, Installer Menu item 118 POWER SAVINGS must be set appropriately. See Installer Menu item 118 description on page 73 and/or Reference section, "*b*-LAN Setup & Overview."
- To control the TV using an external TLT control device, you must use the TV's RS-232C port for communication purposes. See Reference section, "TLT Communication Parameters," for further information.

## Determining the TV Operating Mode

To determine the operating mode of the TV, press **MENU** on the Installer Remote. The menu displayed depends on the operating mode. See examples below.

If the Function Menu appears, the TV is in a mode (FTG, ATM, PPV, etc.) that does not allow the end user to change the fundamental TV setup. If the TV setup menus (Quick Settings) appear, the TV is in Pass-through Mode.

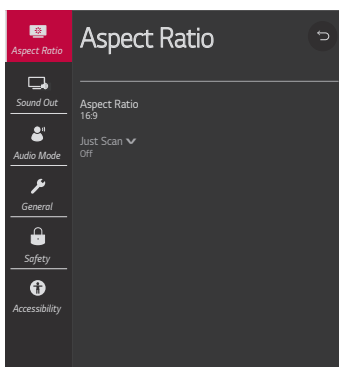

**Function Menu**  
Indicates the TV is not in Pass-through Mode. While the TV is in this mode, Installer Menu settings can be accessed as read-only.

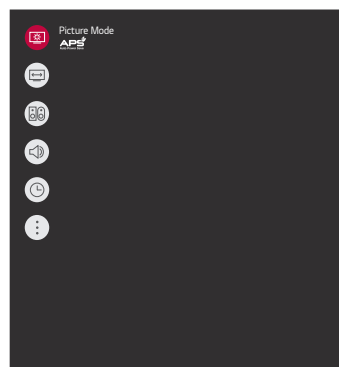

**TV Setup Menus**  
Shows that the TV is in Pass-through Mode.

# Pro:Centric Operation

---

These TV models support LG's Pro:Centric Java application, as well as the Pro:Centric Direct HTML application. Only one application may be implemented at a time. The following sections provide an overview of the application features and functionality.

## Interactive Menu Features

Both the Pro:Centric Java (GEM) application and the Pro:Centric Direct HTML application enable patients and visitors to locate and select television entertainment, check the daily weather, view hospital and surrounding amenities, etc. via custom portal interactive menus. The Pro:Centric Java application provides multiple templates for portal interactive menus, while the Pro:Centric Direct HTML application, in addition to providing multiple templates for portal interactive menus, also enables you to custom-create portal and application content.

Pro:Centric application features include:

- Portal and information screens/pages (including a "Welcome" page) that include branding logos.
- An optional customized user interface (custom "skins").
- Billboards and points-of-interest maps that can be customized to focus on hospital amenities, local attractions and businesses, hotels, restaurants, news, events, etc.
- An optional Weather billboard that includes a local radar map, current conditions, and a four day forecast.
- An interactive channel guide that provides a channel list with channel icons. An electronic program guide (EPG) is an optional feature that displays up to three days of programming information viewable by channel and time.
- Video spooling that enables the hospital to deliver a video file to patient and visitor TVs for promotion and information purposes.

In addition to the those indicated above, the Pro:Centric Direct HTML application also offers the following features:

- Optional messaging features, including notices, ticker text, and ad banners.
- Additional media support, specifically music accompaniment, for portal displays.
- An optional flight information display.

For each Pro:Centric application, an Admin Client web editor/content wizard is provided for customer configuration of portal content. The Pro:Centric Direct Admin Client features the Pro:Centric Direct Project Editor, which provides design tools (including templates) that enable customization of all portal pages. Please contact your LG service representative for further information.

**Note:** Customized content is typically defined by the service integrator and/or hospital administrators. LG does not provide hospital-specific content.

## Interactive Menu Navigation

LG's Pro:Centric pillow speaker provides access to both interactive menus and regular TV features. Press **PORTAL** on the Pro:Centric pillow speaker to access the interactive menus.

Interactive menu options may vary, depending on Pro:Centric features enabled for the site and/or customized content. The following examples show typical portal interactive menus.



Example: Pro:Centric Java (GEM) Application Portal

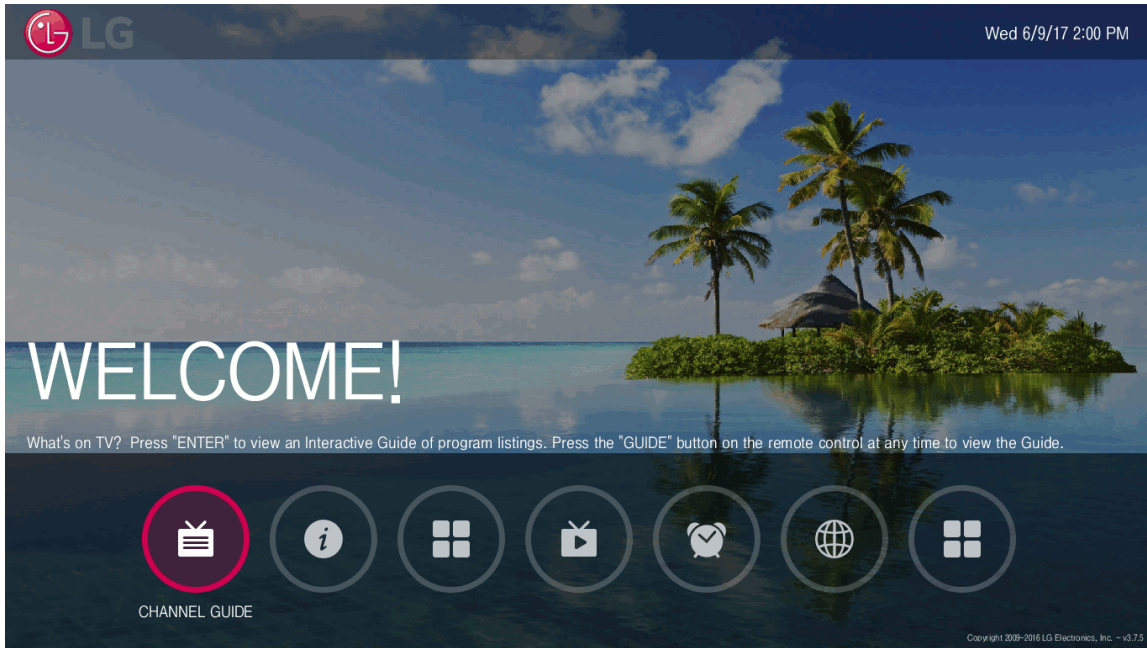

Example: Pro:Centric Direct HTML Application Portal

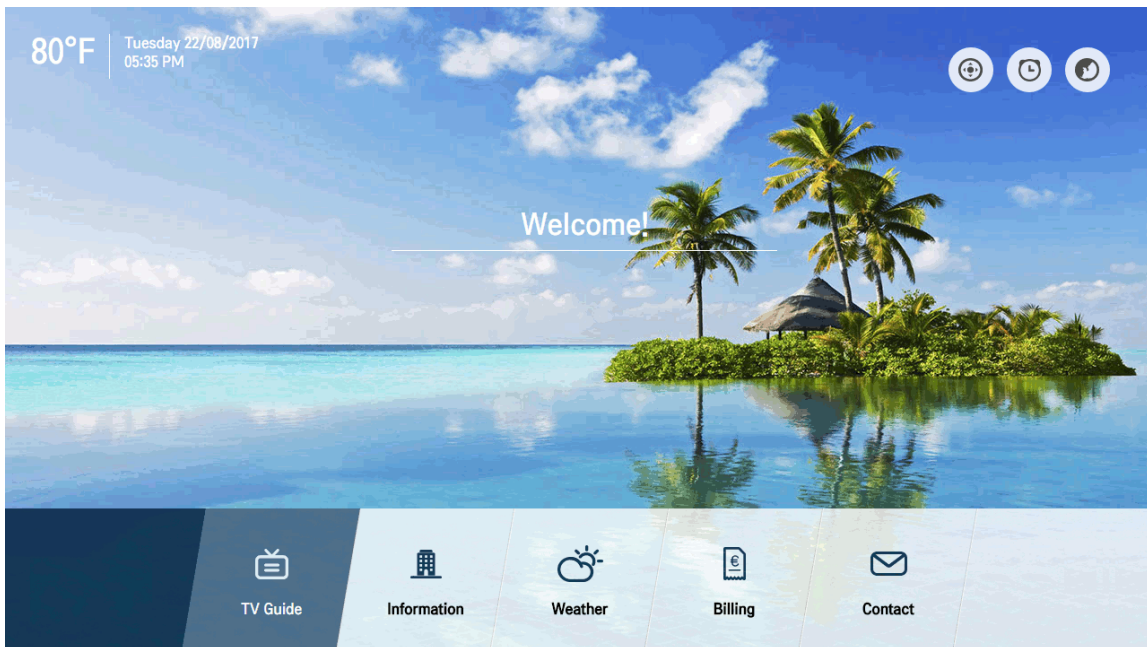



# Pro:Centric Operation (Cont.)

---

## Pro:Centric Java Application Setup

The Pro:Centric Java (GEM) application operates in conjunction with FTG and PPV Modes. This section provides an overview of the setup required for the Pro:Centric features. Administration and management options for the Pro:Centric server are described in detail in the **Pro:Centric Server Admin Client User Guide**. This document describes only those settings that must be specified on the TVs to enable Pro:Centric remote management and/or the Pro:Centric Java application.

- Remote management (TV E-Z Installation): The Pro:Centric Admin Client provides remote management facilities for downloading boot logo image and software updates as well as facilities for downloading a Clone/Configuration (.tlx) file for FTG Mode via CPU configuration.
- Pro:Centric Java application: The application comprises the Pro:Centric interactive menus/features described on page 14. Pro:Centric application settings are managed via the Pro:Centric Admin Client for the Java application.

The Pro:Centric remote management facilities and application download are based on Installer Menu item settings that are used to set up the TV's Pro:Centric features. The Installer Menu / Pro:Centric server settings can be configured using one of the methods described below.

**Note:** If using a Pro:Centric pillow speaker, also set Installer Menu item 027 HOSPITAL MODE to the required value.

### TV in Factory Default State

When the TV is in a factory default state, LG's First Use Wizard provides automated or manual options for configuring the TV's Pro:Centric server settings. See "First Use Wizard" on pages 19 to 21 for further information. The First Use / EZ-Manager Wizard (i.e., Advanced Settings) also provides a USB configuration option that enables you to configure a TV for FTG Mode via CPU using a Clone/Configuration (.tlx) file stored on a USB memory device. The ".tlx" file incorporates FTG Installer Menu settings, including Installer Menu items 098 PRO:CENTRIC and 119 DATA CHANNEL, which are used to set up the TV's Pro:Centric features.

### TV in Pass-through Mode

If the First Use Wizard has been exited and the TV is in Pass-through Mode, use one of the following options, in accordance with the Pro:Centric server output:

- RF output: Set Installer Menu items 098 PRO:CENTRIC and 119 DATA CHANNEL to the appropriate values. See Installer Menu information on pages 61 to 74 for further details. Also, as necessary, refer to "Custom Master TV Setup" on pages 75 to 78 and/or cloning information on pages 79 to 85.
- RF or IP output: Configure the appropriate Pro:Centric server settings in the IP Environment / Pro:Centric Menu. See "Accessing the IP Environment Menu" on page 93 and "Pro:Centric Setup" on pages 98 to 102 for further information.

**Note:** When the TV is in either Pass-through Mode or FTG Mode via CPU, you can also leave Installer Menu item 119 DATA CHANNEL set to its default value (255) to enable the TV's Data Channel Auto Search feature to set the DATA CHANNEL value. See item 119 description on page 73 for additional information.

### TV in FTG Mode

If the TV is already in FTG Mode (via CPU or EBL), use the appropriate FTG application to update Installer Menu items #98 Pro:Centric and #119 Data Channel (along with their affiliated fields). Then, transfer the FTG Installer Menu settings to the TV in accordance with the FTG Mode of configuration. Refer to the FTG Mode overview on pages 9 to 11 for further information on FTG Mode operation and configuration. Also—for FTG Mode via CPU only—see note above regarding the option to use the TV's Data Channel Auto Search feature to set the DATA CHANNEL value.

## Pro:Centric Direct HTML Application Setup

The Pro:Centric Direct HTML application operates only in Application Tuning Mode (ATM). This section provides an overview of the setup required for the Pro:Centric Direct features. Administration and management options for the Pro:Centric server are described in detail in the applicable Admin Client User Guide—either the *Pro:Centric Direct Admin Client User Guide* or the *Pro:Centric Cloud Admin Client User Guide*. This document describes only those settings that must be specified on the TVs to enable Pro:Centric remote management and/or the Pro:Centric Direct HTML application.

- Remote management (TV E-Z Installation): The Pro:Centric Direct Admin Client provides remote management facilities for downloading boot logo image and software updates as well as facilities for downloading Installer Menu configuration updates via Clone (.tlx) file to the TVs at the property.  
**Note:** The Pro:Centric Direct Channel Map is created and maintained in the Pro:Centric Direct Admin Client. Thus, any Clone file that is loaded on the server for remote configuration may only contain Installer Menu and/or Setup Menu profiles.
- Pro:Centric Direct HTML application: The application comprises the Pro:Centric interactive menus/features described on page 14. Pro:Centric Direct application settings are managed via the Pro:Centric Direct Admin Client.

The Pro:Centric remote management facilities and application download are based on Installer Menu item settings that are used to set up the TV's Pro:Centric features. The Installer Menu / Pro:Centric server settings can be configured using one of the methods described below.

**Note:** If using a Pro:Centric pillow speaker, also set Installer Menu item 027 HOSPITAL MODE to the required value.

### TV in Factory Default State

When the TV is in a factory default state, LG's First Use Wizard provides automated or manual options for configuring the TV's Pro:Centric server settings. See "First Use Wizard" on pages 19 to 21 for further information and also notes below. The First Use / EZ-Manager Wizard (i.e., Advanced Settings) also provides a USB configuration option that enables you to configure the TV's Installer Menu settings using a Clone (.tlx) file stored on a USB memory device. Installer Menu items 098 PRO:CENTRIC and 119 DATA CHANNEL are used to set up the TV's Pro:Centric features.

**Note:** The automated option referenced above is applicable for an on-site Pro:Centric server only.

**Note:** If the server is configured on LG's Pro:Centric Cloud portal, you will need the six-digit installation code for this property in order to complete the Pro:Centric Cloud server setup on the TV. The installation code is generated in the Pro:Centric Cloud portal. Refer to the *Pro:Centric Cloud Portal User Guide* for further information.

### TV in Pass-through Mode

If the First Use Wizard has been exited and the TV is in Pass-through Mode, use one of the following options, in accordance with the Pro:Centric server output:

- RF output: Set Installer Menu items 098 PRO:CENTRIC and 119 DATA CHANNEL to the appropriate values. See Installer Menu information on pages 61 to 74 for further details. Also, as necessary, refer to "Custom Master TV Setup" on pages 75 to 78 and/or cloning information on pages 79 to 85.
- RF or IP output: Configure the appropriate Pro:Centric server settings in the IP Environment / Pro:Centric Menu. See "Accessing the IP Environment Menu" on page 93 and "Pro:Centric Setup" on pages 98 to 102 for further information.

## Pro:Centric Operation (Cont.)

---

**Note for on-site Pro:Centric server only:** When the TV is in either Pass-through Mode or Application Tuning Mode, you can also leave Installer Menu item 119 DATA CHANNEL set to its default value (255) to enable the TV's Data Channel Auto Search feature to set the DATA CHANNEL value. See item 119 description on page 73 for additional information.

### TV in Application Tuning Mode

If the TV is already in Application Tuning Mode, use a Master TV of the same model to create and export a Clone (.tlx) file with the appropriate settings for Installer Menu items 098 PRO:CENTRIC and 119 DATA CHANNEL. Then, transfer (import) the Clone file to the Target TV. Refer to the Application Tuning Mode / Pro:Centric Direct overview on pages 11 to 12 for further information on Pro:Centric Direct operation and configuration. To transfer the Clone file remotely, use the appropriate utilities in the Pro:Centric Direct Admin Client to upload the Clone file to the Pro:Centric server and set up its distribution to the Target TV(s) at the site. See also note above regarding the option, applicable for an on-site server only, to use the TV's Data Channel Auto Search feature to set the DATA CHANNEL value.

**Note:** After it is turned ON, the TV begins an initialization process, and it may take several minutes for the First Use Wizard to appear.

LG's First Use Wizard, comprising multiple configuration options, will appear on the screen each time the TV is turned ON, until one of its configuration methods has been completed or the wizard is exited. Use the Installer Remote to make selections and complete each step.

- **Basic Settings:** Initiates the Basic Settings Wizard, which enables you to select basic TV settings, including the TV's language and location, and run Channel Tuning. It also allows you to configure the TV's network settings, as well as custom portal settings, if desired. See "Basic Settings Wizard" on pages 22 to 26 for further information.
- **Hospital Settings:** Initiates the Hospital Setup Wizard. The Hospital Setup Wizard guides you through the process of configuring the TV for FTG Mode via CPU operation with Hospital Mode features. This includes setting up the pillow speaker, as required, as well as setting up channel banks (up to four) for tiered channel programming. The Hospital Setup Wizard also enables you to configure the Pro:Centric settings on the TV. See "Hospital Setup Wizard" on pages 27 to 42 for further information.

Note that the Hospital Setup Wizard uses the TV's standard RF Channel Tuning feature to initially create the TV's channel lineup; IP channels may be added manually as part of the Channel Map editing process.

- **Advanced Settings** (default): Initiates the EZ-Manager Wizard. The primary purpose of the EZ-Manager Wizard is to guide you through the process either of configuring essential Installer Menu items for Pro:Centric operation with a standard on-site Pro:Centric server or setting up configuration for Pro:Centric operation via LG's Pro:Centric Cloud.

While the EZ-Manager Wizard is intended primarily for Pro:Centric-related configuration, the wizard also offers Zoning and network configuration options and, in addition, enables you to access the TV Manager / USB download options as part of the configuration process, if desired, to perform USB configuration and/or update functions. See "Advanced Settings / EZ-Manager Wizard" on pages 43 to 55 for further information.

- **IP Environment Settings:** Enables you to access the IP Environment Menu to set up network features of the TV, including Pro:Centric and/or Media Share features. See "IP Environment Setup" on pages 93 to 109 for further information.



**Caution: Do NOT unplug the TV power cord or remove the antenna cable or, if applicable, the LAN cable during the configuration process, as doing so will interrupt the current step and may corrupt the configuration data.**



**Note: If you do not intend to complete the Hospital Setup Wizard, but you wish to enable Hospital Mode (pillow speaker functionality and also channel banks), you must set Installer Menu item 027 HOSPITAL MODE appropriately. See the "Installer Menu" section of this document for further information.**

## Before You Begin

- If you plan to create a customized Master TV Setup using the procedure described on pages 75 to 78, be sure to exit the LG First Use Wizard in order to avoid setup conflicts or setting modes that may cause unintended behavior or restrict the custom setup procedure. See also "Initiate Configuration or Exit the First Use Wizard" on the following page.

# First Use Wizard (Cont.)

- If it has been completed or exited and therefore does not display, the First Use Wizard can be reactivated; however, this requires that you restore the TV to a factory default condition. See Reference section, “Restoring Factory Defaults on the TV(s),” for further information.
- If you would like to enable the SoftAP and/or Beacon Media Share features or select pre-loaded / Smart Launcher applications on a TV that will eventually be configured for FTG Mode, you will need to use the IP Environment Menu to do so before the TV is configured for FTG Mode. You can access the IP Environment Menu from the First Use Wizard or from the Installer Menu. See “Initiate Configuration or Exit the First Use Wizard” below for information on accessing the IP Environment Menu from the First Use Wizard, and refer to “IP Environment Setup” on pages 93 to 109 for detailed information on the IP Environment Menu (as well as information on accessing the IP Environment Menu from the Installer Menu). See also “Custom Master TV Setup” on pages 75 to 78, as necessary.

## Initiate Configuration or Exit the First Use Wizard

The Welcome screen provides a brief introduction to the First Use Wizard.

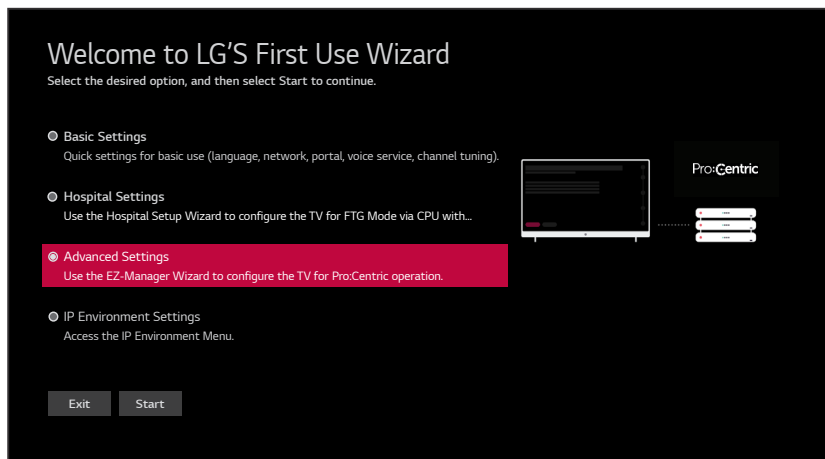

Use the arrow keys on the Installer Remote to select the desired option in the Welcome screen:

- To proceed with the Basic Settings Wizard, select/highlight **Basic Settings**, and then press **OK**. Then, select **Start** and press **OK** to continue. See “Basic Settings Wizard” on pages 22 to 26 for further information.
- To proceed with the Hospital Setup Wizard, select/highlight **Hospital Settings**, and then press **OK**. Then, select **Start** and press **OK** to continue. See “Hospital Setup Wizard” on pages 27 to 42 for further information.
- To proceed with the EZ-Manager Wizard, select/highlight **Advanced Settings**, and then press **OK**. Then, select **Start** and press **OK** to continue. See “Advanced Settings / EZ-Manager Wizard” on pages 43 to 55 for further information.
- To access the IP Environment Menu, select/highlight **IP Environment Settings**, and then press **OK**. Then, select **Start** and press **OK** to continue. See “IP Environment Setup” on pages 93 to 109 for further information.

- To exit the First Use Wizard, select/highlight the **Exit** button at the bottom of the screen, and then press **OK**. In the exit confirmation screen, select **Exit**, and then press **OK** once more on the Installer Remote.

**Note:** Both the EZ-Manager Wizard and the Hospital Setup Wizard enable you to configure Pro:Centric settings on this TV, even if you do not intend to configure any of the additional settings available. After you configure the Pro:Centric settings, you will have the option to exit without completing the remainder of the EZ-Manager Wizard or Hospital Setup Wizard (as applicable), if desired.

**Note:** If you exit the First Use Wizard from the Welcome screen, no configuration will be performed and all Installer Menu items will retain their default values, including Installer Menu item 119 DATA CHANNEL. The default DATA CHANNEL setting (255) means that the Pro:Centric remote management feature on this TV will be activated if a Pro:Centric server is installed on-site and the Data Channel value is set during a Data Channel Auto Search (see item 119 description on page 73 for additional information). If you actually would like to disable the Pro:Centric feature, the EZ-Manager Wizard, Hospital Setup Wizard, and the IP Environment Menu provide an option to do so, and/or you may disable Pro:Centric by setting the value of Installer Menu item 119 to 0.

**Note:** If a USB device, with an exported Clone file for this model, is inserted while the Welcome screen is on display, a pop-up screen will enable you to proceed directly to the TV Manager / Ez Download utility, if desired, to facilitate the process of importing the Clone file.

# Basic Settings Wizard

This section describes the configuration options available when you select “Basic Settings” from the First Use Wizard / Welcome screen. You can select the “Back” button, where available, to check previous settings, as necessary.

**Note:** Each Basic Settings Wizard step is allotted a 10-second time frame after which the wizard proceeds automatically. If default settings are appropriate, the wizard can proceed through each of the configuration steps with no further user interaction. If you turn OFF the TV while the wizard is in progress, when you turn the TV back ON, the First Use Wizard / Welcome screen will be displayed. You will then have the opportunity to (re)initiate the desired configuration process.

**Note:** To exit the wizard at any time, use the arrow keys on the Installer Remote to select/highlight the **X** button at the top right of the screen, and then press **OK**. In the exit confirmation screen, select **Exit**, and then press **OK** once more on the Installer Remote.

1. In the Language & Location screen, use the arrow keys on the Installer Remote to select/highlight each appropriate field in turn—Language or Time Zone—and then press **OK**. Then, use the up/down arrow keys to select the applicable value from the drop-down list of options for the selected field. When you are ready to continue, use the arrow keys on the Installer Remote to select **Next**, and then press **OK**.

**Note:** The Country field is inaccessible/grayed out because these models are only available in the US. Also, if you allow the wizard to progress without specifying data in this screen, the time zone will be set for “New York” (Eastern Standard Time).

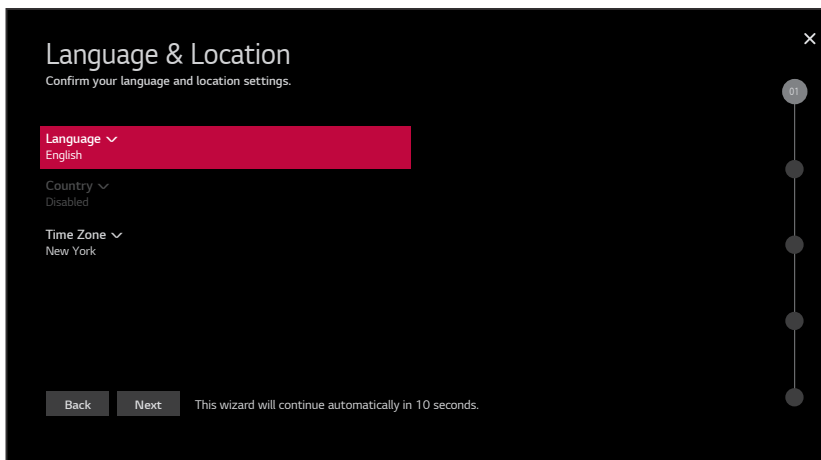

2. The next screen enables you to configure the network settings of the TV. Refer to the appropriate subsection(s) below for information on configuring the wired and/or wireless connection(s) between the TV and the network. When you are ready to continue, use the arrow keys on the Installer Remote to select **Next**, and then press **OK**.

**Note:** If desired, you can configure both wired and wireless connections to the Local Area Network (LAN). However, note that a wired connection is always prioritized over a wireless connection. That is, if an Ethernet cable is connected between the network and the TV’s LAN port, the TV will default to the wired connection. If the Ethernet cable is removed, the TV will then attempt to establish the wireless connection. Whenever the Ethernet cable is reconnected to the TV’s LAN port, the TV will re-establish the wired connection.

(Continued on next page)



(Continued from previous page)

**Note:** If an Ethernet cable is not currently connected between the TV and the network and you do not want to configure/complete configuration of network settings at this time, you can select/highlight **Skip**, and press **OK** on the Installer Remote to continue to the next step.

## Configure a Wired Network Connection

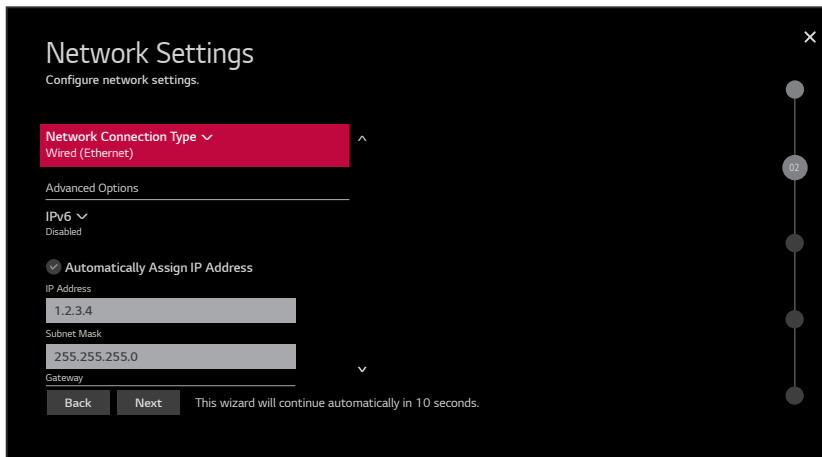

- a. If not already done, connect the appropriate cable between the TV and the network.
- b. Make sure the **Wired (Ethernet)** option is selected in the Network Connection Type field, and then press **OK** on the Installer Remote.
- c. By default, the TV uses DHCP, and if a LAN is detected, the TV will request an IP address from the DHCP server on the network. If the TV is able to connect to the network, the network configuration data will be displayed on the screen as shown in the example above.  
If the network is not configured for DHCP, or if you want to enable/disable IPv6 or specify static IP configuration data (applicable only for IPv4), continue with steps (d) and/or (e), respectively.
- d. (Optional) To enable IPv6, select/highlight the IPv6 field and press **OK**. Then, select **Enabled** from the drop-down list of options.
- e. (Optional / IPv4 only) If required, you can edit the IP data for this TV as follows:
  - De-select the “Automatically Assign IP Address” checkbox under “Advanced Options.”
  - For each data entry field: Use the arrow keys on the Installer Remote to select the field and press **OK**. You can use the number keys on the Installer Remote to direct enter numeric values or use the arrow keys to select the appropriate characters from the pop-up virtual keyboard displayed at the bottom of the screen. When you are done, select **Enter** from the virtual keyboard, and then press **OK** on the Installer Remote.

**Note:** You must use the dot “.” key from the virtual keyboard to separate each octet of an IP address.

(Continued on next page)

# Basic Settings Wizard (Cont.)

(Continued from previous page)

## Configure a Wireless (Wi-Fi) Network Connection

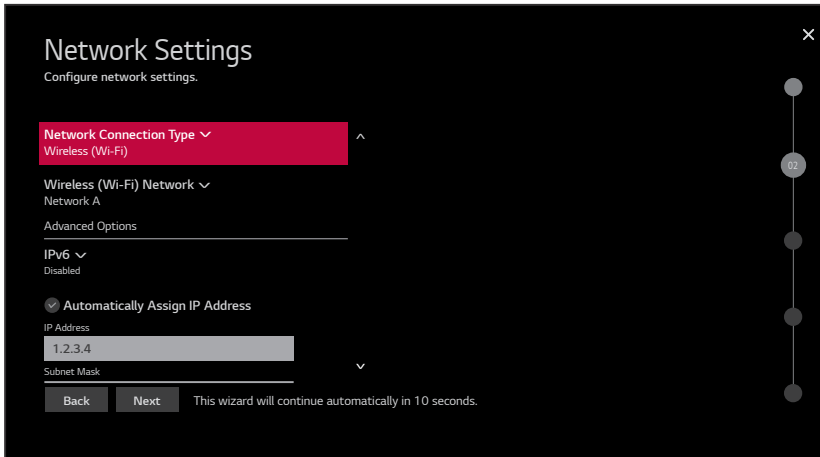

- a. Select/highlight the Network Connection Type field, and press **OK** on the Installer Remote. Then, use the Up/Down arrow keys to select/highlight **Wireless (Wi-Fi)**, and press **OK** once more.
- b. Select/highlight the Wireless (Wi-Fi) Network field, and press **OK** on the Installer Remote. Then, use the Up/Down arrow keys to select/highlight the desired access point from the drop-down list of available options, or select the “Hidden Network” option at the bottom of the list to specify an access point with a hidden SSID. Press **OK** once more.

**Note:** Make sure you have the network security password—at least eight, but no more than 32 characters—or PIN available if you are attempting to connect to a secured network. If you would like to add an access point with a hidden SSID, you will need to direct enter the SSID—up to 32 characters—of the access point.

- c. Follow the on-screen instructions to complete the appropriate network configuration. Use the Installer Remote to navigate between fields and make entries, etc.

**Note:** As with a wired connection, you will have the option to specify static IPv4 configuration data for this network connection. Once the initial connection is established, you can de-select the “Automatically Assign IP Address” checkbox under “Advanced Options,” and then modify the IP data, as required. See step (e) of the wired connection procedure above for further information on the data entry fields.

- d. (Optional) To enable IPv6, select/highlight the IPv6 field and press **OK**. Then, select **Enabled** from the drop-down list of options.
- e. Once the wireless network configuration is complete, use the arrow keys on the Installer Remote to select **Connect**, and then press **OK** on the Installer Remote to continue.

**Note:** The “Connect” button becomes a “Next” button once the connection is successful.

(Continued on next page)

(Continued from previous page)

3. In the Portal Settings screen, you can specify the Portal Mode and the Portal Auto Start status for this TV. Use the arrow keys on the Installer Remote to select/highlight each appropriate field in turn—Portal Mode or Portal Auto Start—and then press **OK**. Then, use the up/down arrow keys to select the applicable value from the drop-down list of options for the selected field. When you are ready to continue, use the arrow keys on the Installer Remote to select **Next**, and then press **OK**.

**Note:** Customizable portal settings are for TVs that will NOT be configured for Pro:Centric operation. If the “Customizable Portal” option is selected in the Portal Mode field, you will be redirected to the IP Environment / Portal Settings Menu when this wizard is complete, so that you can configure the custom portal settings. The Portal Auto Start status is either “On” (display the portal when the TV is turned ON) or “Off” (do not display the portal when the TV is turned ON).

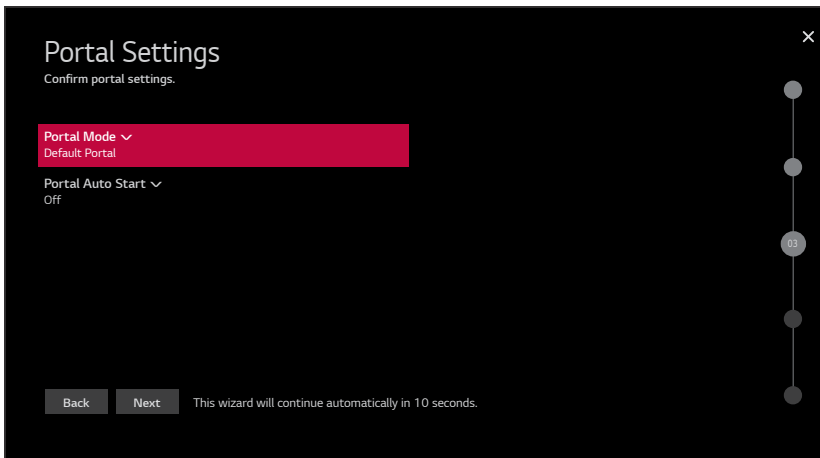

4. In the Voice Service Coverage screen, use the arrow keys on the Installer Remote to select/highlight each appropriate field in turn—LG Service Country or Service Area Zip Code—and then press **OK**. Then, use the up/down arrow keys to select the applicable value from the drop-down list of options for the selected field. When you are ready to continue, use the arrow keys on the Installer Remote to select **Next**, and then press **OK**.

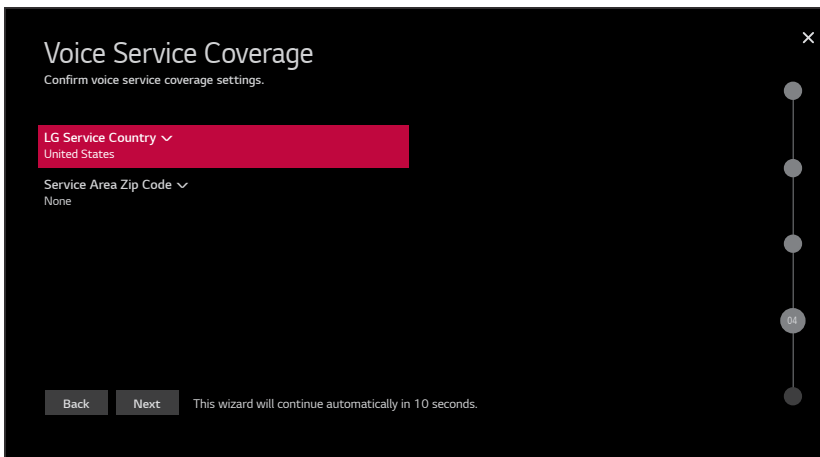

(Continued on next page)

## Basic Settings Wizard (Cont.)

---

(Continued from previous page)

5. The Channel Tuning screen is the final step of the Basic Settings Wizard.

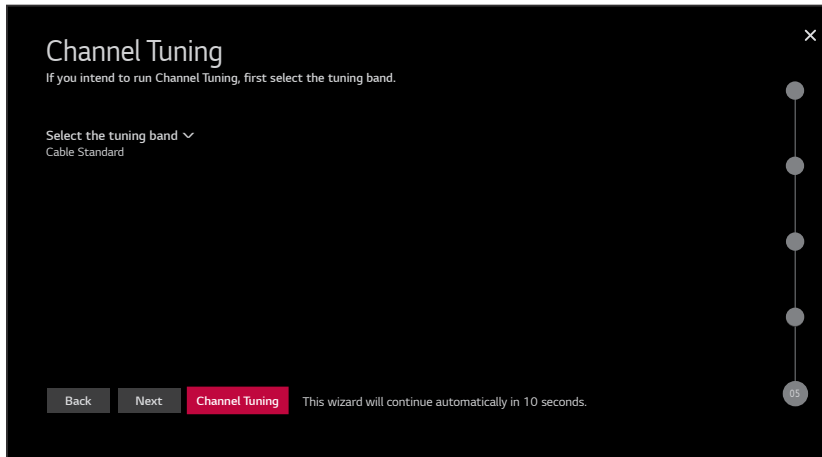

- If you would like to initiate an automated channel scan (i.e., a search for all available digital and analog channels), use the arrow keys on the Installer Remote to select the RF tuning band field, and select the appropriate option. Then, press **OK**. Next, select the **Channel Tuning** button at the bottom of the screen, and press **OK**.

Tuning progress will be shown in a new Channel Tuning screen. The scan typically takes a few minutes. When the channel scan is complete, the TV will launch the IP Environment Menu. See additional information below.

- If you would like to continue with the basic TV setup without running Channel Tuning, select the **Done** button at the bottom of the screen, and press **OK**. The TV will launch the IP Environment Menu. See additional information below.

As indicated above, the IP Environment Menu is always launched after the Basic Settings Wizard is complete (and once Channel Tuning is finished, if applicable). If you selected the "Customized Portal" option in the Portal Settings screen, the IP Environment / Portal Settings Menu will be on display when the IP Environment Menu launches, and you can configure the portal, as desired. If you did not select "Customized Portal," the IP Environment Menu launches with the Network Menu options on display (default IP Environment Menu launch scenario). See "IP Environment Setup" on pages 93 to 109 for further information on the options available in the IP Environment Menu.

This section describes the configuration options available when you select “Hospital Settings” from the First Use Wizard / Welcome screen.

You can select the “Back” button, where available, to check previous settings, as necessary. Typically, if you do not modify the default settings, the “Next” button is automatically selected when you proceed forward within the Hospital Setup Wizard. Where appropriate, you can simply press **OK** on the Installer Remote to proceed to the next step if the default value(s) for the TV parameter(s) in question are applicable for your installation.

**Note:** The Hospital Setup Wizard configures the TV for FTG Mode operation with Hospital Mode features (exception: if Channel Tuning is not run, the TV will not be configured for FTG Mode operation upon the completion of the Hospital Setup Wizard). This means that while the TV is functioning in FTG Mode, Hospital Mode is enabled, i.e., Installer Menu item 027 HOSPITAL MODE is not set to 0. In addition, you can create custom channel lineups for channel banks 1 to 4.

**Note:** While the Hospital Setup Wizard enables you to set up TVs individually in lieu of cloning, you can also use the resulting Hospital TV Setup for cloning purposes, if desired. However, note that TV setup menu customization via the Hospital Setup Wizard is limited to Channels Menu options.

**Note:** To exit the wizard at any time, use the arrow keys on the Installer Remote to select/highlight the **✕** button at the top right of the screen, and then press **OK**. In the exit confirmation screen, select **Exit**, and then press **OK** once more on the Installer Remote.

## Pro:Centric Settings

Step 1 of the Hospital Setup Wizard enables you to set up the Pro:Centric feature of the TV. The default Data Channel setting (Auto Search) means that the Pro:Centric remote management feature on this TV will be activated if a Pro:Centric server is installed on-site and the Data Channel value is set during a Data Channel Auto Search (see screen example below). See also item 119 DATA CHANNEL description on page 73 for further information. The Pro:Centric Application Mode default setting is “Configuration Only,” which enables remote management only. That is, the TV will search for TV E-Z Installation data downloads; however, Pro:Centric application data will not be downloaded, i.e., Installer Menu item 098 PRO:CENTRIC will be set to 0.

- If you wish to proceed with the wizard without changing the default values for the Pro:Centric settings, you can simply select **Next** and press **OK** on the Installer Remote.
- If you wish to exit the wizard while retaining the default values for Pro:Centric settings, use the arrow keys on the Installer Remote to select **Done**, and then press **OK**.
- If you already know the Pro:Centric settings that need to be configured in order for the TV to connect to an on-site, even if not yet installed, Pro:Centric server, use the “Standard Pro:Centric Server Configuration” procedure on pages 28 to 29 to expedite the setup process.
- If you will be using LG’s Pro:Centric Cloud solution to configure the TVs at the site for Pro:Centric operation, see “Pro:Centric Cloud Server Configuration” on page 30 to complete the Pro:Centric configuration.

**Note:** If you would like to disable the Pro:Centric feature of the TV, select the Data Channel field, and then use the Left/Right arrow keys on the Installer Remote to select **Disabled**. From here, you may opt to proceed with the wizard (select **Next**) or save this setting and exit the wizard (select **Done**). See also step 4 of the Standard Pro:Centric Server Configuration procedure below.

# Hospital Setup Wizard (Cont.)

## Standard Pro:Centric Server Configuration

Complete the following steps to configure settings for an on-site Pro:Centric server. Use the Up/Down arrow keys on the Installer Remote to navigate between the fields.

1. Make sure the Server Type field in the Pro:Centric Server section of the screen is set to **Standard Pro:Centric Server Settings** (default). If necessary, use the Left/Right arrow keys on the Installer Remote to change the setting.

The remaining steps of this procedure describe the fields in the Pro:Centric Configuration section of the screen.

2. In the Pro:Centric Mode field, use the Left/Right arrow keys on the Installer Remote to select the appropriate Pro:Centric Application Mode—**GEM** (Java), **HTML**, or **Configuration Only**.

**Note:** For remote management only, select **Configuration Only**. The TV will search for TV E-Z Installation data downloads; however, Pro:Centric application data will not be downloaded, i.e., Installer Menu item 098 PRO:CENTRIC will be set to 0.

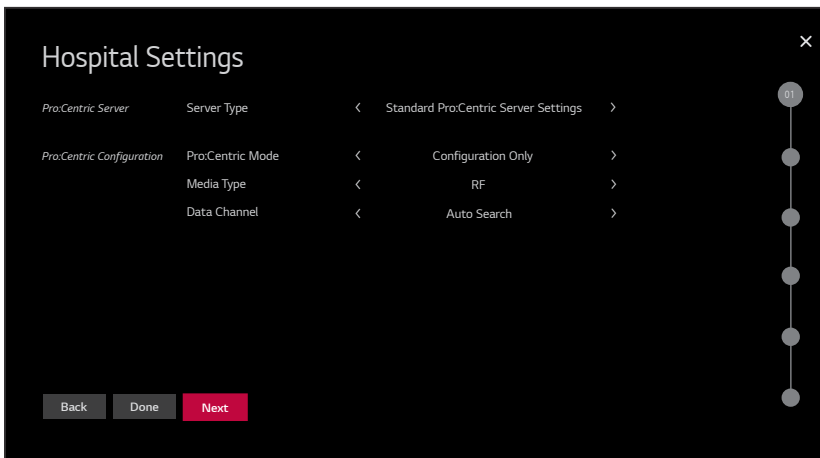

Pro:Centric Configuration Screen with RF Media Fields

**Note:** By default, the Pro:Centric Configuration screen initially shows RF configuration fields.

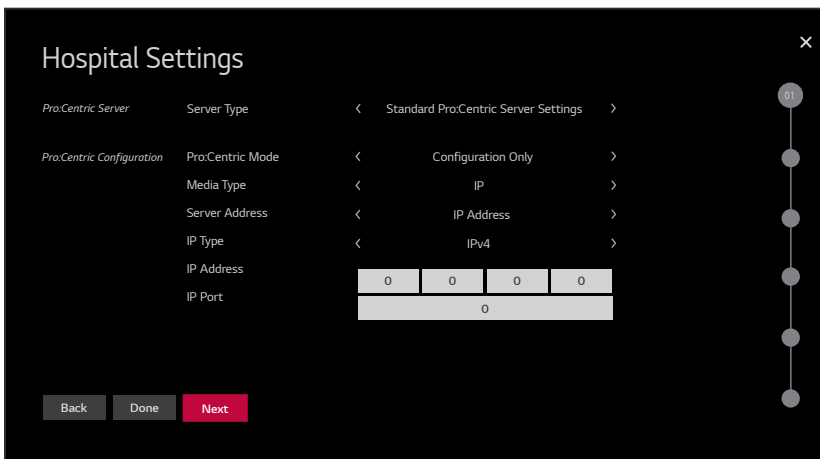

Pro:Centric Configuration Screen with IP Media Fields

(Continued on next page)

\* PCS150R and later Pro:Centric servers do not support HRC or IRC cable channel frequencies.

(Continued from previous page)

3. Refer to the appropriate subsection below, depending on the Pro:Centric server configuration, to complete the remaining fields.

### *RF Configuration*

- a) In the Media Type field, use the Left/Right arrow keys on the Installer Remote to select **RF**.
- b) In the Data Channel field, use the Left/Right arrow keys to select the RF channel number that will be used by the Pro:Centric server as its data channel. The Data Channel value can be set from 1 to 135.\*

### *IP Configuration*

- a) In the Media Type field, use the Left/Right arrow keys on the Installer Remote to select **IP**.  
**Note:** When you select “IP” as the Media Type, the default RF Data Channel field is replaced with Server Address, IP Type, IP Address, and IP Port fields.
- b) The Server Address field provides the option to specify the domain name of the Pro:Centric server instead of the server’s IP address. Use the Left/Right arrow keys to select the desired option—**IP Address** or **Domain Name**—for defining the server.
- c) Depending on your selection in the previous step, either:
  - Select the appropriate IP type (either IPv4 or IPv6) in the IP Type field, and then enter the Pro:Centric server IP address in the IP Address field. The IP address must match the IPv4 or IPv6 (as applicable) address that is set in the Pro:Centric server.
  - Enter the Pro:Centric server domain name—up to 63 characters (no spaces allowed)—in the Domain Name field. Note that in order for the domain name to be resolved to an IP address, there must be a DNS entry for the domain name.

For each data entry field: Use the arrow keys to select the field and press **OK**. Then, you can either use the number keys on the Installer Remote to direct enter data values, or you can use the arrow keys to select the appropriate number(s)/alphanumeric character(s) from the pop-up virtual keyboard displayed at the bottom of the screen. When you are done, select **Enter** from the virtual keyboard, and then press **OK** on the Installer Remote.

**Note:** For an IPv6 IP address, you must use the colon “:” key from the virtual keyboard to separate each group.

- d) Enter the Pro:Centric server port number in the IP Port field. The port number must match the port number that is set in the Pro:Centric server.
4. Once all fields are completed as required, you have two options:
    - To proceed with TV configuration via the Hospital Setup Wizard, select **Next** and press **OK** on the Installer Remote. Continue to “Enable/Disable Aux Inputs” below.
    - To save the data entered and exit the Hospital Setup Wizard, use the arrow keys to select **Done** and then press **OK** on the Installer Remote. Remember, however, that if you do not complete the Hospital Setup Wizard, pillow speaker functionality will not be enabled unless you set Installer Menu item 027 HOSPITAL MODE appropriately. See the “Installer Menu” section of this document for further information.



# Hospital Setup Wizard (Cont.)

## Pro:Centric Cloud Server Configuration

This section describes how to complete the TV's Pro:Centric configuration when the (virtual) server is configured on LG's Pro:Centric Cloud portal (applicable only with CPU v4.41.00 or later and PTC v1.00.011 or later). You will need the six-digit installation code for this property in order to set up the Pro:Centric Cloud server configuration.

**Note:** The installation code is generated in the Pro:Centric Cloud portal. A user with an Administrator role for this property must provide/generate the code. The procedure below also assumes this property has already been added to the Pro:Centric Cloud portal. Refer to the **Pro:Centric Cloud Portal User Guide** for further information.

1. In the Pro:Centric Server section at the top of the screen, use the Left/Right arrow keys on the Installer Remote to select **LG Pro:Centric Cloud Settings** in the Server Type field.

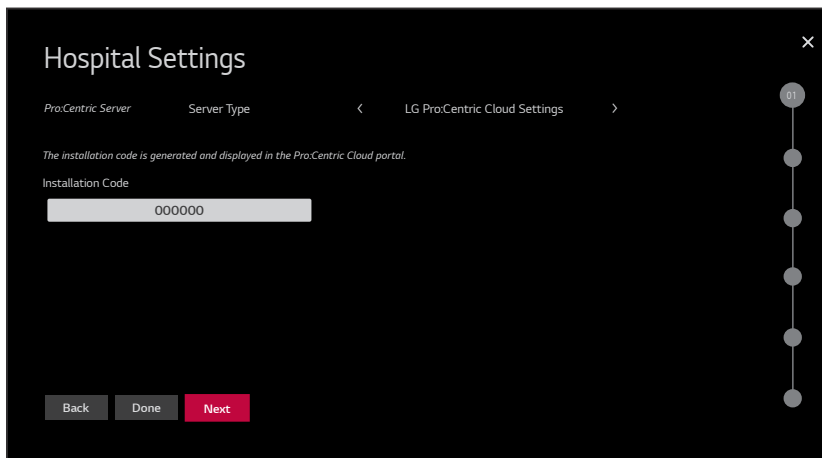

2. Use the Up/Down arrow keys on the Installer Remote to select the Installation Code field and press **OK**.
3. Enter the six-digit installation code in the Installation Code field. You can either use the number keys on the Installer Remote to direct enter the installation code, or you can use the arrow keys to select the appropriate numbers from the pop-up virtual keyboard displayed at the bottom of the screen.
4. Use the arrow keys to select **Search** and press **OK** to verify the installation code. When the installation code is verified, the "Search" button becomes a "Next" button (you also will see a "Server Found" message below the Installation Code field).
5. You have two options:
  - To proceed with TV configuration via the Hospital Setup Wizard, select **Next** and press **OK** on the Installer Remote. Continue to "Enable/Disable Aux Inputs" below.
  - To save the data entered and exit the Hospital Setup Wizard, use the arrow keys to select **Done** and then press **OK** on the Installer Remote. Remember, however, that if you do not complete the Hospital Setup Wizard, pillow speaker functionality will not be enabled unless you set Installer Menu item 027 HOSPITAL MODE appropriately. See the "Installer Menu" section of this document for further information.

## Enable/Disable Aux Inputs



**Note:** If you choose to exit the Hospital Setup Wizard from this point on, any settings made will not be retained.

By default, all Aux inputs are enabled as shown initially in step 2 of the Hospital Setup Wizard (see sample screen below). In this step, you can disable the Aux input(s), as necessary, and/or you can decide whether or not to include the enabled Aux input(s) in the FTG Channel Map.

1. To disable an Aux input, use the arrow keys on the Installer Remote to select the desired input, and then press **OK** to toggle the status of the Aux input.

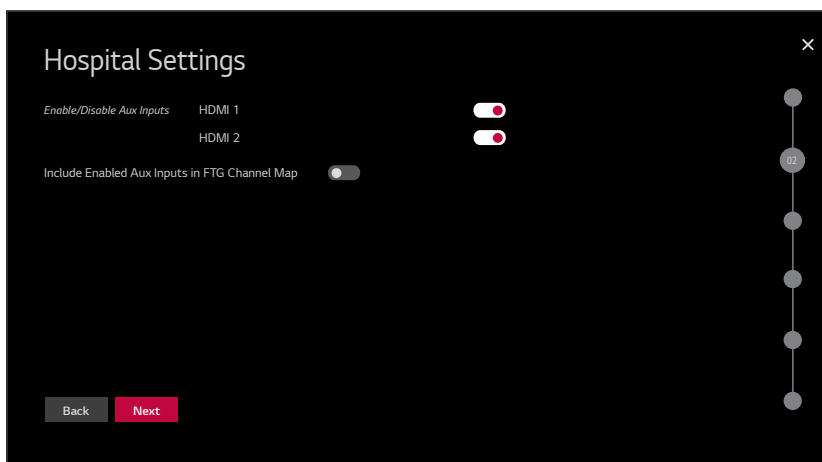

2. If you would like to include enabled Aux inputs in the FTG Channel Map, use the arrow keys on the Installer Remote to select the “Include Enabled Aux Inputs...” field, and then press **OK** to toggle this option to ON.
3. When you are ready to continue, use the arrow keys to select **Next**, and then press **OK**.

**Note:** After the Hospital Setup Wizard is complete, the only way to add or remove enabled Aux inputs to/from the FTG Channel Map created by the wizard, is to export a Clone (.tlx) file from the TV, edit the FTG Channel Map using the Cloud Configuration Tool, and then import the edited Clone file to the TV. See “Cloning Procedures” on pages 79 to 85 and/or “Cloud Configuration Tool Overview” on pages 86 to 92 and/or Reference section, “TV Aux Input Configuration,” for further information.

**Note:** If you wish to enable a disabled Aux input in the future, you may do so by changing the applicable Installer Menu settings in the Cloud Configuration Tool. See also note above.

## Set Up Hospital Mode Features (Channel Banks/Zones & Speaker/IR Settings)

In step 3 of the Hospital Setup Wizard, you can enable and set up TV elements related to Hospital Mode. Refer to the subsections below.

When you are ready to continue, use the arrow keys to select **Next**, and then press **OK**.

(Continued on next page)

# Hospital Setup Wizard (Cont.)

(Continued from previous page)

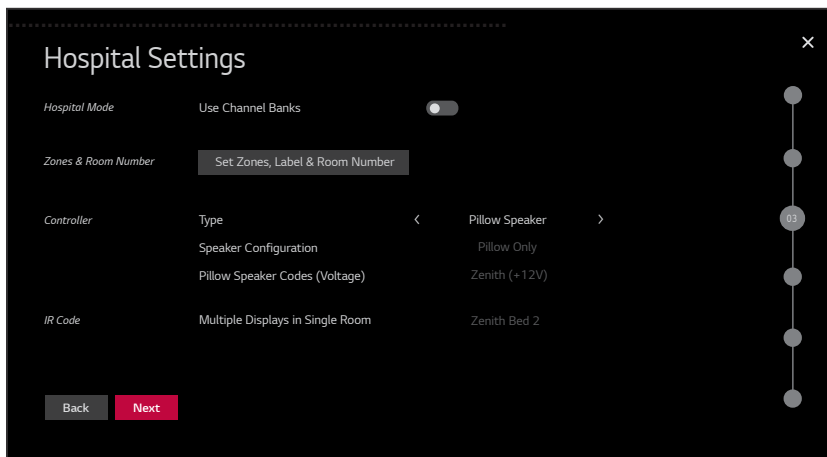

## Hospital Mode

The enabled/disabled status of channel banks in this section of the screen is used initially to determine the status of Hospital Mode—i.e., enabled or disabled—as channel banks are only available for use when Hospital Mode is enabled. This setting, along with the Controller settings in this screen, sets Installer Menu item 027 HOSPITAL MODE, which also means that when the Hospital Setup Wizard is complete, the TV will be operating in FTG Mode via CPU with Hospital Mode features enabled. See item 027 description on page 68 for further information.

By default, Hospital Mode is enabled and channel banks are applied. See also Installer Menu item 027 description on page 68. To disable Hospital Mode, use the arrow keys on the Installer Remote to select the Use Channel Banks toggle button, and press **OK** on the Installer Remote to toggle the status to Off.

**Note:** When Hospital Mode is enabled, i.e., channel banks are automatically applied, the (Lodging) TV Zoning feature is not available, and a Zones & Room Number section/field will NOT be displayed.

**Note:** When Hospital Mode is disabled, the (Lodging) TV Zoning feature is enabled, and a Zones & Room Number section/field will be displayed (as shown in the example above). In this case, Installer Menu item 020 FEATURE LEVEL determines the appropriate IR code scheme. See also “Channel Banks Overview” on pages 40 to 42 and/or Reference section, “Using the TV’s Zoning Features,” for further information.

## Zones, Label, and Room Number

**Note:** The (Lodging) TV Zoning feature is only available when Hospital Mode is disabled, as described above. The option to set up this feature is not accessible if Hospital Mode/channel banks are enabled.

If you intend to use the Zoning feature(s) on the TV for location-specific configuration purposes, complete the following steps.

1. Select **Set Zones, Label and Room Number**, and press **OK**.

(Continued on next page)

(Continued from previous page)

In the Zones, Label, and Room Number screen, you may complete one or more of the fields or leave them at their default settings (TV Zone and Wi-Fi Zone) or blank (Label and Room Number), as desired. However, if you intend to use either of the Zoning features—TV Zoning and/or Wi-Fi Zoning—on this TV, you **MUST** specify the appropriate values in the TV Zone and/or Wi-Fi Zone fields as described below. See Reference section, “Using the TV’s Zoning Features,” for further information.

**Note:** Zoning features are only applicable for TVs that will be configured using a “.tlx” file (local or remote configuration). Also note that TV Zoning is only available when Installer Menu item 027 HOSPITAL MODE is set to 0 (i.e., Hospital Mode is disabled). See item 027 description on page 68.

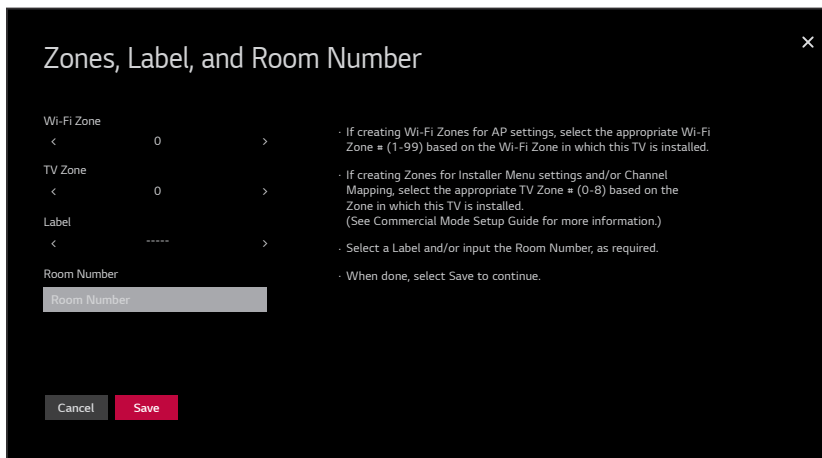

2. Complete the appropriate field(s) as described below. Use the Up/Down arrow keys on the Installer Remote to navigate between each of the fields.

- **Wi-Fi Zone:** Enables you to set a Wi-Fi Zone # so that the TV can be configured with a particular access point’s login data for wireless networking. Login data (i.e., SSID, security type, and security key) may be provided in a Clone/Configuration (.tlx) file.

To assign a Wi-Fi Zone, navigate to the Wi-Fi Zone field at the top left of the screen, and use the Left/Right arrow keys to specify the desired Wi-Fi Zone # (1–99).

- **TV Zone:** Enables you to set a TV Zone # so that the TV can be configured with Installer Menu and/or Setup Menu settings intended only for the assigned Zone. The Installer Menu and/or Setup Menu settings may be provided in a Clone/Configuration (.tlx) file. If the TV is being configured for FTG Mode via CPU, the TV Zone # setting also allows the TV to omit channels that have been restricted in the FTG Channel Map.

To change the TV Zone from its default value (0), navigate to the TV Zone field, and use the Left/Right arrow keys to specify the desired TV Zone # (1–8).

- **Label:** Allows you to select a North, South, East, or West text label for this TV. In the Label field, use the Left/Right arrow keys to select the applicable label.

(Continued on next page)

# Hospital Setup Wizard (Cont.)

---

(Continued from previous page)

- **Room Number:** Allows you to specify the number of the room—up to 16 characters—in which the TV is located. To enter a room number, navigate to the Room Number field and press **OK**. You can then use the number keys on the Installer Remote to directly enter a room number, or you can use the arrow keys to select the appropriate alphanumeric character(s) from the pop-up virtual keyboard at the bottom of the screen. When you are done, select **Enter** from the virtual keyboard, and then press **OK** on the Installer Remote.

**Note:** The TV name (default: “[LG] webOS TV” + the TV’s model name) will be changed to the room number specified here. See “Media Share Setup” on pages 107 to 109 for further information on the TV name.

3. When you are ready to continue, use the arrow keys to select **Save**, and then press **OK** on the Installer Remote to return to the Hospital Settings screen. Then, proceed as required.

## Controller

In this section of the screen, you can select the speaker configuration for the TV. Use the arrow keys on the Installer Remote to select the appropriate controller type and configuration values:

- **Type:** Use the Left/Right arrow keys to select the desired controller type—**Pillow Speaker** (wired remote) (default) or **IR** (remote).

**Note:** A “Pillow Speaker” selection in this field means that the Multiple Displays in Single Room field in the IR section at the bottom of the screen will be grayed out. In addition, when “Pillow Speaker” is selected here and Hospital Mode is disabled as described above, Speaker Configuration and Pillow Speaker Codes fields also will be grayed out.

**Note:** If you select “IR” in this field, the Speaker Configuration and Pillow Speaker Codes (Voltage) fields will be grayed out. Proceed to select the required value in the Multiple Displays in Single Room field in the IR section at the bottom of the screen.

- **Speaker Configuration:** If applicable, use the Left/Right arrow keys to select the desired speaker configuration—**Pillow Only** (default) or **Pillow & TV**.
- **Pillow Speaker Codes (Voltage):** If applicable, use the Left/Right arrow keys to select the appropriate pillow speaker IR code scheme/voltage—**Zenith (+12V)** (default), **Philips (+5V)**, or **RCA (-5V)**.

**Note:** If using a Pro:Centric pillow speaker (LG IR codes) or a pillow speaker with Zenith IR codes, make sure the “Zenith” (+12V) pillow speaker codes (voltage) are selected.

## IR Code

When the Controller Type above is set to “IR,” in this section of the screen, you can select the bed number for this TV. Use the Left/Right arrow keys to select the desired bed number in the Multiple Displays in Single Room field: **Zenith Bed 2**, **Zenith Bed 1**, or **LG Multi-code IR Bed 1-16**. This setting is based on Installer Menu item 020 FEATURE LEVEL (see description on page 68).

## Channel Tuning

In step 4 of the Hospital Setup Wizard, you will be able to initiate an automated digital and/or analog channel scan and also edit the channel lineup. Refer to the subsections below.

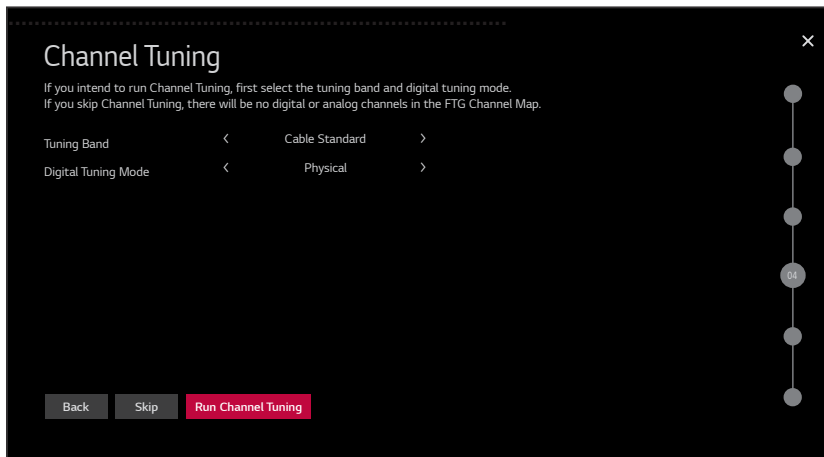

### Run Channel Tuning

**Note:** If you do not want to run Channel Tuning, use the arrow keys on the Installer Remote to select **Skip** and press **OK**. Then, go to step 3 of the procedure below. See also note below.

**Note:** If you move on to the next step of the Hospital Setup Wizard without running Channel Tuning and/or without manually adding channels, there will be no digital or analog RF channels or IP channels in the channel lineup. In this case—and only if you opted to include enabled Aux inputs in the FTG Channel Map in step 2 of the Hospital Setup Wizard (see “Enable/Disable Aux Inputs” on page 31)—upon completion of the Hospital Setup Wizard, the only channels in the resulting FTG Channel Map will be any enabled Aux inputs.

1. Select the appropriate Tuning Band and Digital Tuning Mode values, as required. Use the arrow keys to navigate between the two fields.
  - Tuning Band: Use the Left/Right arrow keys on the Installer Remote to select the appropriate tuning band option: Cable Standard (default), Cable HRC, Cable IRC, or Air.
  - Digital Tuning Mode: Use the Left/Right arrow keys on the Installer Remote to select the appropriate tuning mode option: Physical or Virtual.
2. Select **Run Channel Tuning** at the bottom of the screen, and press **OK** on the Installer Remote to start the channel scan.

Channel Tuning progress will be shown in a new Channel Tuning screen. Unless you opt to skip one or the other, the scan searches for all available digital and analog channels and typically takes a few minutes. When the channel scan is complete, a “Completed Channel Tuning” message will be displayed on the screen, and the following button options will now be available at the bottom of the screen:



(Continued on next page)

# Hospital Setup Wizard (Cont.)

(Continued from previous page)

- Once Channel Tuning completes successfully, or if you opted to skip Channel Tuning, you can now either:
    - Select **Next** and press **OK** on the Installer Remote to continue to the next step of the Hospital Setup Wizard.
    - Select **Edit Channel Map** and press **OK** on the Installer Remote to edit (e.g., customize and/or add channels to) the Channel Map. Continue with “Edit the Channel Map” below.
- Note:** Select **Retry** and press **OK** on the Installer Remote, as necessary, to rerun the scan.

## Edit the Channel Map

This section describes how to edit the Channel Map. See also “Run Channel Tuning” above.









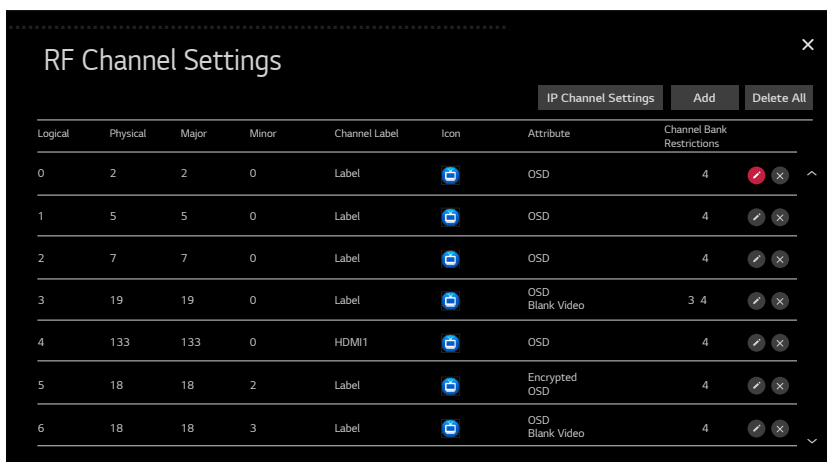











 **Note:** If, for any reason, you elect to re-run Channel Tuning after editing the Channel Map as described below, your current custom channel settings will be lost, and you will need to replicate the desired customization.

In the RF Channel Settings and IP Channel Settings screens, you can customize the channel lineup (add channels, channel labels, icons, etc.). You can also set up channel banks or Zones (depending on your Hospital Mode selection in step 3 of the Hospital Setup Wizard). See also examples below.

**Note:** IP Channels need to be added manually.

**Note:** Logical channels 3 & 4 in the RF Channel Settings screen example below illustrate enabled Aux inputs in the FTG Channel Map.



Logical	Physical	Major	Minor	Channel Label	Icon	Attribute	Channel Bank Restrictions
0	2	2	0	Label		OSD	4  
1	5	5	0	Label		OSD	4  
2	7	7	0	Label		OSD	4  
3	19	19	0	Label		OSD Blank Video	3 4  
4	133	133	0	HDMI1		OSD	4  
5	18	18	2	Label		Encrypted OSD	4  
6	18	18	3	Label		OSD Blank Video	4  

RF Channel Settings Screen with (Hospital Mode) Channel Bank Restrictions

**Note:** These screens are intended as examples only. If Channel Banks are in use, it is not possible to set Zone Restrictions, and vice versa.

(Continued on next page)

(Continued from previous page)

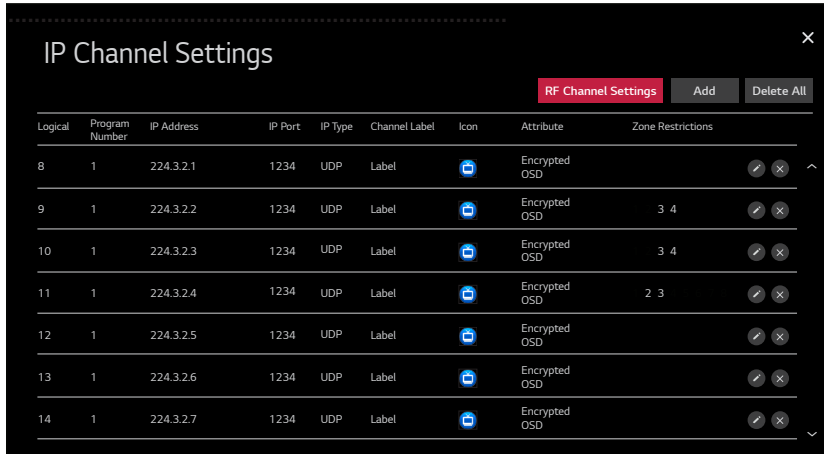

IP Channel Settings Screen with (Lodging) Zone Restrictions

**Note:** These screens are intended as examples only. If Channel Banks are in use, it is not possible to set Zone Restrictions, and vice versa.

For each channel, the (RF or IP) Channel Settings screen identifies the channel's logical number, the RF or IP details (as applicable) of the channel, the channel label, the channel icon, the channel's attributes (Encrypted, OSD, or Blank Video), and the channel's Bank or Zone restrictions (depending on your previous Hospital Mode selection).

1. Use the arrow keys to navigate between the channels, fields, and button options, and edit the Channel Map as required:
  - To switch between RF Channel Settings and IP Channel Settings screen, select the **RF Channel Settings** or **IP Channel Settings** button, as applicable, at the top right of the screen and then press **OK** on the Installer Remote.
  - To delete all channels in the Channel Settings screen currently on display (RF or IP), select the **Delete All** button at the top right of the screen and press **OK** on the Installer Remote. At the prompt for confirmation, select **No** or **Yes**, as applicable, and press **OK** on the Installer Remote.
  - To add a channel, make sure you have the required Channel Settings screen (RF or IP) on display, select the **Add** button at the top right of the screen, and press **OK** on the Installer Remote. An Add Channel pop-up window will be displayed, and you can specify the channel details as required, for example:

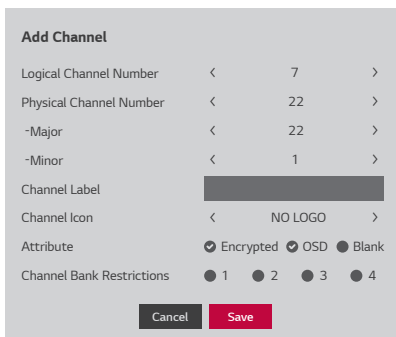

Add RF Channel

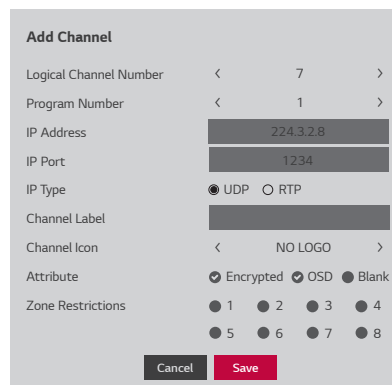

Add IP Channel

(Continued on next page)



# Hospital Setup Wizard (Cont.)

---

(Continued from previous page)



**Note:** These screens are intended as examples only. If Channel Banks are in use, it is not possible to set Zone Restrictions, and vice versa.

**Note:** If you enabled Hospital Mode, all channels found during Channel Tuning, as well as all enabled Aux inputs (if you opted to include enabled Aux inputs in the FTG Channel Map in step 2 of the Hospital Setup Wizard), automatically are added to and active in all four channel banks. See also “Channel Banks Overview” on pages 40 to 42.

Use the arrow keys on the Installer Remote to navigate between the fields.

- In the Channel Label field, press **OK** to display the pop-up virtual alphanumeric keyboard, and add a custom text label for each channel/Aux input (up to 17 characters), as desired.
- The Channel Icon field enables you to select the appropriate trademark/icon for each channel’s Channel-Time on-screen display. If known, you can direct enter the icon number using the number keys on the Installer Remote. Otherwise, use the Left/Right arrow keys on the Installer Remote to select/highlight the desired logo. Icons are available for familiar channels, such as ABC, CBS, NBC, etc. Identifiable icons should enable the end user to readily know what common networks are available.
- For IP Address and IP Port data entry fields, you can use the number keys on the Installer Remote to direct enter numeric values, or you can use the arrow keys to select the appropriate alphanumeric characters (as applicable) from the pop-up virtual keyboard displayed at the bottom of the screen (once you select the field and press **OK** on the Installer Remote). When you are done, select **Enter** from the virtual keyboard, and then press **OK** on the Installer Remote. Note that for the IP address, you must use the dot “.” key from the virtual keyboard to separate each octet of an IP address.

When you are finished, select **Save** and press **OK** on the Installer Remote (or select **Cancel** and press **OK** to return to the Channel Settings screen without adding the channel).

- To modify a channel, select the  button at the right of the applicable channel and press **OK** on the Installer Remote. In the Modify Channel pop-up window, you can edit the channel details as necessary. See also bullet above for additional information on the fields.
  - To delete a single channel, select the  button at the right of the applicable channel and press **OK** on the Installer Remote. At the prompt for confirmation select **No** or **Yes**, as applicable, and press **OK** on the Installer Remote.
2. When you are ready to return to the Channel Tuning screen, use the arrow keys to select the  button at the top right corner of the Channel Settings screen, and then press **OK** on the Installer Remote.

## Select Channel Banner, Scan Mode, and Power On Settings

In step 5 of the Hospital Setup Wizard, you can select the channel tuning / banner display format, enable/disable Scan Mode, and/or configure Power On settings. Refer to the subsections below. When you are ready to continue, use the arrow keys to select **Next**, and then press **OK**.

(Continued on next page)

(Continued from previous page)

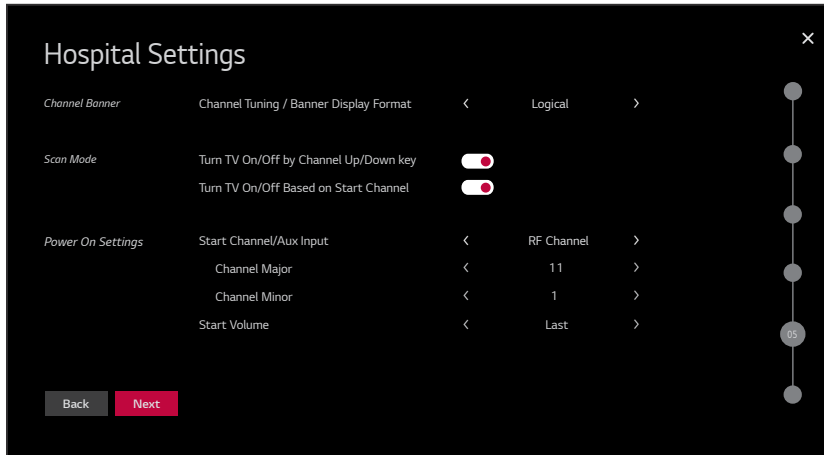

## Channel Banner

In this section of the screen, you can select the channel tuning / banner display format. Use the Left/Right arrow keys on the Installer Remote to select the desired format option—either Logical (default) or Physical—for the installation site.

## Scan Mode

This section of the screen allows you to enable/disable the Scan Mode settings for this TV. See also Installer Menu item 013 SCAN MODE and 014 STRT CH IN SM descriptions on page 67 for further information. Use the arrow keys on the Installer Remote to select the Turn TV On/Off by Channel Up/Down Key toggle button and/or the Turn TV On/Off Based on Start Channel toggle button, and press **OK** on the Installer Remote to toggle the status as required.

## Power On Settings

This section of the screen allows you to select the desired Start Channel / Aux Input and Start Volume settings. Use the arrow keys to navigate between the fields, and select the appropriate values as follows:

- Start Channel / Aux Input: Use the Left/Right arrow keys to select the appropriate value—RF Channel, IP Channel, Aux Input, or Last Channel—in this field. See also Installer Menu item 004 STRT CHANNEL description on page 66 and/or Installer Menu item 046 STRT AUX SRCE description on page 70.
- (Start RF or IP Channel only): Select/enter the appropriate value(s) in the channel detail fields.
- (Start Aux Input only): Use the Left/Right arrow keys to select the desired Aux input.
- Start Volume: Use the Left/Right arrow keys to select the desired value (0 to 100 or “Last”) for the Start Volume. See also Installer Menu item 007 STRT VOLUME description on page 67.

# Hospital Setup Wizard (Cont.)

## Complete the Hospital Settings

This is the final step of the Hospital Setup Wizard. The TV will save your settings and use the channel/Aux input lineup to create an FTG Channel Map before configuring the TV for FTG Mode (see also notes below).

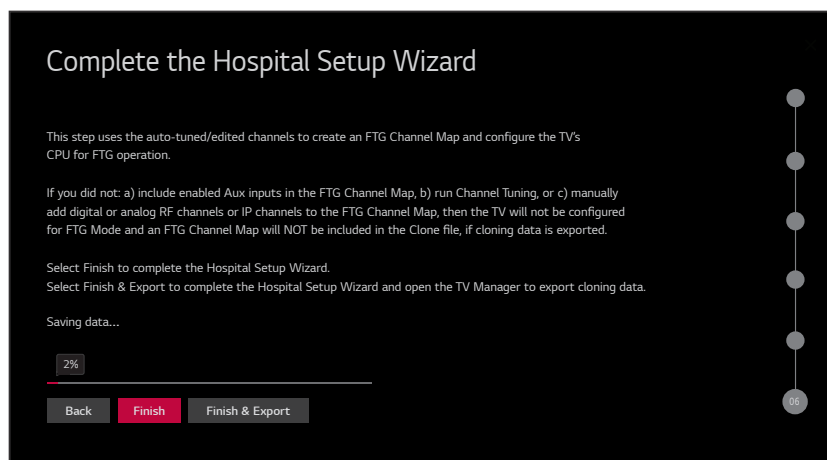

When you are ready to proceed, either:

- Select **Finish**, and then press **OK** to complete the wizard.
- Select **Finish & Export**, and then press **OK** to complete the wizard and open the TV Manager so that you can export the cloning data (see “Exporting a Clone File” on pages 79 to 81 for further information).

Configuration progress will be shown at the bottom of the screen. When this step is complete, the Hospital Setup Wizard exits, and the TV either tunes to the first channel in the FTG Channel Map or redirects to the TV Manager in accordance with your selection above. Also, when the Hospital Setup Wizard is complete, if channel banks are applicable, the TV is set for Channel Bank 1. If required, you can set up/modify channel banks at a later time using LG's Cloud Configuration Tool. See “Channel Banks Overview” on pages 40 to 42 for further information.

**Note:** Aux inputs, if included in the FTG Channel Map, will appear between the highest analog and lowest digital channel number when Channel Up/Down is used on the Installer Remote.

**Note:** If you did not run Channel Tuning or manually add channels or opt to add enabled Aux inputs, an FTG Channel Map will NOT be created and the TV will not be configured for FTG Mode via CPU.

## Channel Banks Overview

Channel banks enable institution administrators to create tiered channel programming on patient in-room TVs. Each channel bank may offer a custom channel lineup for a pre-determined fee. The Hospital Setup Wizard enables you to configure four channel banks (1, 2, 3, and 4) for the Channel Map (see “Channel Tuning” on pages 35 to 38). The top tier generally contains the most programming (premium, etc.), 2nd tier = lesser programming, 3rd tier = basic programming, etc. It is also possible to create an Inactive TV display with Channel Bank 4, so that an “Inactive TV Call Attendant” message appears when the TV is turned ON. In this case, an administrator can then select another channel bank on the patient's in-room TV depending on the programming tier requested by the patient.

All channels found during Channel Tuning, as well as all enabled Aux inputs (if you opted to include enabled Aux inputs in the FTG Channel Map in step 2 of the Hospital Setup Wizard), automatically are added to and active in all four channel banks. See “Channel Attributes and Channel Bank Restrictions” below for further information. If you would like to modify channel banks after completing the Hospital Setup Wizard, you can save (export) the FTG Channel Map to a USB memory device and then use the Cloud Configuration Tool to make the required changes (see also “Updating Channel Attributes and/or Channel Bank Restrictions” below).

**Note:** Channel banks are automatically applied in the Hospital Setup Wizard when Hospital Mode is enabled, which means that the (Lodging) TV Zoning feature is not available. To disable channel banks and enable the TV Zoning feature, Hospital Mode must be disabled. See “Hospital Mode” on page 32 and also Installer Menu item 027 HOSPITAL MODE description on page 68 for further information.

### Channel Attributes and Channel Bank Restrictions

Three attributes are available for each channel: Encrypted, OSD, and Blank Video. When the TV creates an FTG Channel Map upon completion of the Hospital Setup Wizard, the OSD attribute (displays the channel number, label, and icon) is automatically assigned to all channels, and the Encrypted attribute is assigned to each Pro:Idiom encrypted channel detected during the channel scan. The Blank Video attribute is not assigned automatically to any channels; however, as part of the Channel Tuning step of the Hospital Setup Wizard, you have the option to assign the “Blank” attribute to channels, as required. When you assign the Blank attribute to a channel, this means that the channel audio will be audible; however, its video will be black (no picture). The Blank attribute applies to the channel regardless of channel bank allocation.

Once you have selected a channel’s attribute(s), determine the channel bank restrictions, if any. Select each channel bank from which to restrict the channel. That is, the channel will not appear in the channel lineup of the channel bank(s) from which it has been restricted.

### Selecting a Channel Bank

Once the Hospital Setup Wizard is complete, to select a channel bank on the TV, press **CH BANK** on the Installer Remote. The first time you press the CH BANK key, the TV display will show the currently active channel bank (default = Channel Bank 1). Each successive CH BANK key press selects channel banks numerically, i.e., from Channel Bank 1 to Channel Bank 4. Press **CH BANK** repeatedly until the desired channel bank is selected.

### Updating Channel Attributes and/or Channel Bank Restrictions

If, after the Hospital Setup Wizard is complete, you would like to modify channel attributes and/or channel bank restrictions and/or update the FTG Channel Map in general, you can save (export) the FTG Channel Map to a USB memory device (see “Exporting a Clone File” on pages 79 to 81) and then use the Cloud Configuration Tool / Channel Map web page to make the required changes. On the Channel Map web page, Zones 1 to 4 are used to create custom channel lineups for channel banks 1 to 4. A checked Zone Restriction (1 to 4) checkbox means that the selected channel is “restricted” from the same numbered channel bank. Refer to the Channel Map web page overview on page 90 and also the **Cloud Configuration Tool User Guide** for further information. The Cloud Configuration Tool is available at: [cct.procentric.tv](http://cct.procentric.tv).

## Hospital Setup Wizard (Cont.)

---



**Note: Hospital Mode channel banks and Lodging TV Zoning are mutually exclusive features of these TV models. If you wish to use channel banks, do not change the TV Zone # during a custom TV setup, as the TV Zone # will be used to track channel banks (banks are selected after configuration using the CH BANK key on the Installer Remote as described above). If it becomes necessary to import a “.tlx” file with Installer Menu updates, in order to ensure that the Installer Menu settings are accepted by all US772M TVs regardless of their current channel bank, you must also ensure that the new Installer Menu profile has a Zone 0 assignment. For additional information on TV Zoning, see Reference section, “Using the TV’s Zoning Features.”**

### Inactive TV Setup

To create an inactive TV display on Channel Bank 4, you need to restrict each channel from Channel Bank 4. You can do this in the Hospital Setup Wizard, or you can use the Cloud Configuration Tool, as indicated above, to make changes.

When the TV is turned ON by the patient, an “Inactive TV Call Attendant” message will appear on the screen, and after a few moments the TV will turn itself OFF. This will prompt the patient to arrange for an available programming package on Channel Bank 1, 2, or 3. Using the Installer Remote, the administrator can select Channel Bank 1, 2, or 3 depending on the entertainment programming tier selected by the patient. When the patient leaves the hospital, the administrator can then select Channel Bank 4 to reinstate the “Inactive TV” message.

This section describes the EZ-Manager Wizard that is initiated when you select “Advanced Settings” from the First Use Wizard / Welcome screen.

**Note:** If a Pro:Centric server is installed on-site and configured on the system/network and if no location-specific settings are required in the TV, i.e., (Lodging) TV Zone, Wi-Fi Zone, Label, and/or Room Number settings, you can simply turn ON the TV, and once initiated, the wizard will proceed through each of the configuration steps with no further user interaction.

**Note:** Select the “Back” button, where available, to check previous settings, as necessary. Also note that if you turn OFF the TV while the wizard is in progress, when you turn the TV back ON, a “Diagnostics” screen will be displayed (see also note below).

**Note:** If any of the configuration steps fails, you will see a “Diagnostics” screen with an indication of the failure. You will then have the opportunity to reinstate the configuration process from the previous screen or exit the EZ-Manager Wizard.

## TV Configuration Options

In the TV Configuration Options screen, you can choose how to proceed with the configuration of this TV.



**Note:** If you intend to use the Zoning feature(s) on the TV for location-specific configuration purposes, select the “Zones & Room Number” option from this screen and set the appropriate TV Zone # and/or the Wi-Fi Zone # in the TV BEFORE you continue with additional configuration.

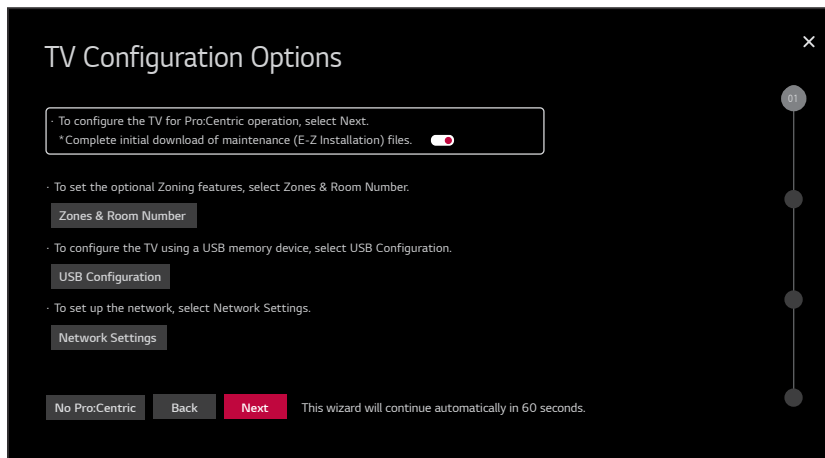

**Note:** If there is no user action in this screen within one minute, the wizard will automatically continue to the next configuration step. If you would like to exit the wizard at any time, use the arrow keys on the Installer Remote to select/highlight the **X** button at the top right of the screen, and then press **OK**. In the exit confirmation screen, select the appropriate “Exit” option (see also note below), and then press **OK** once more on the Installer Remote.

**Note:** If you choose to exit the EZ-Manager Wizard from this point on, you will have the option to save any settings made by selecting **Save & Exit** in the exit confirmation screen. Or, you can exit the wizard without saving any settings by simply selecting **Exit** in the confirmation screen.

(Continued on next page)

# Advanced Settings / EZ-Manager Wizard (Cont.)

(Continued from previous page)

Use the Up/Down arrow keys on the Installer Remote to navigate between options on this screen.

- If you do not intend to install/configure a Pro:Centric server on this system and you do not wish to use any of the additional options available from this screen, exit the wizard as follows: Select **No Pro:Centric**, and then press **OK**. This will disable the Pro:Centric feature of this TV (i.e., Installer Menu item 119 DATA CHANNEL will be set to 0) and exit the wizard. In the exit confirmation screen, select **Exit**, and then press **OK** once more on the Installer Remote.
- To continue with Pro:Centric configuration, select **Next** (default) and press **OK** on the Installer Remote. See “Pro:Centric Settings” on page 48 for additional information.

**Note for on-site Pro:Centric server:** By default, any applicable maintenance (E-Z Installation) files are downloaded as part of the TV configuration. If you would like to skip the initial maintenance file download, select the  (Yes) toggle button on the screen and press **OK** to change the value to  (No). Maintenance files will still be downloaded during the daily update event, per Installer Menu item 121 setting.

- To set the Zoning feature(s) on the TV, select **Zones & Room Number**. See “Zones and Room Number Assignments” below for further information.
- To configure the network settings of the TV, select **Network Settings**. See “Network Settings” on pages 45 to 47 for further information.
- To access the TV Manager / USB download options, select **USB Configuration**. See “USB Configuration” on pages 53 to 55 for further information.

## Zones and Room Number Assignments

You may complete one or more of the fields in the Zones, Label, and Room Number screen or leave them at their default settings (TV Zone and Wi-Fi Zone) or blank (Label and Room Number), as desired. However, if you intend to use either of the Zoning features—TV Zoning and/or Wi-Fi Zoning—on this TV, you **MUST** specify the appropriate values in the TV Zone and/or Wi-Fi Zone fields as described below. See Reference section, “Using the TV’s Zoning Features,” for further information.

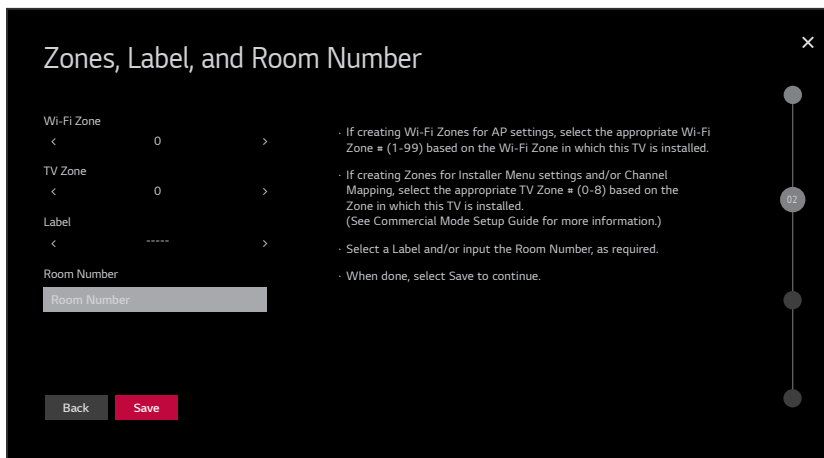

(Continued on next page)



# Advanced Settings / EZ-Manager Wizard (Cont.)

---

(Continued from previous page)

**Note:** Zoning features are only applicable for TVs that will be configured using a “.tlx” file (local or remote configuration). Also note that TV Zoning is only available when Installer Menu item 027 HOSPITAL MODE is set to 0 (i.e., Hospital Mode is disabled). See item 027 description on page 68.

1. Complete the appropriate field(s) as described below. Use the Up/Down arrow keys on the Installer Remote to navigate between each of the fields.

- **Wi-Fi Zone:** Enables you to set a Wi-Fi Zone # so that the TV can be configured with a particular access point's login data for wireless networking. Login data (i.e., SSID, security type, and security key) may be provided in a Clone/Configuration (.tlx) file.

To assign a Wi-Fi Zone, navigate to the Wi-Fi Zone field at the top left of the screen, and use the Left/Right arrow keys to specify the desired Wi-Fi Zone # (1–99).

- **TV Zone:** Enables you to set a TV Zone # so that the TV can be configured with Installer Menu and/or Setup Menu settings intended only for the assigned Zone. The Installer Menu and/or Setup Menu settings may be provided in a Clone/Configuration (.tlx) file. If the TV is being configured for FTG Mode via CPU, the TV Zone # setting also allows the TV to omit channels that have been restricted in the FTG Channel Map.

To change the TV Zone from its default value (0), navigate to the TV Zone field, and use the Left/Right arrow keys to specify the desired TV Zone # (1–8).

- **Label:** Allows you to select a North, South, East, or West text label for this TV. In the Label field, use the Left/Right arrow keys to select the applicable label.
- **Room Number:** Allows you to specify the number of the room—up to 16 characters—in which the TV is located. To enter a room number, navigate to the Room Number field and press **OK**. You can then use the number keys on the Installer Remote to direct enter a room number, or you can use the arrow keys to select the appropriate alphanumeric character(s) from the pop-up virtual keyboard at the bottom of the screen. When you are done, select **Enter** from the virtual keyboard, and then press **OK** on the Installer Remote.

**Note:** The TV name (default: “[LG] webOS TV” + the TV's model name) will be changed to the room number specified here. See “Media Share Setup” on pages 107 to 109 for further information on the TV name.

2. When you are ready to continue, use the arrow keys to select **Save**, and then press **OK** on the Installer Remote to return to the TV Configuration Options screen. Then, proceed as required from the TV Configuration Options screen.

## Network Settings

You may configure wired and/or wireless network settings for the TV.

**Note:** If desired, you can configure both wired and wireless connections to the Local Area Network (LAN). However, note that a wired connection is always prioritized over a wireless connection. That is, if an Ethernet cable is connected between the network and the TV's LAN port, the TV will default to the wired connection. If the Ethernet cable is removed, the TV will then attempt to establish the wireless connection. Whenever the Ethernet cable is reconnected to the TV's LAN port, the TV will re-establish the wired connection.

(Continued on next page)

# Advanced Settings / EZ-Manager Wizard (Cont.)

(Continued from previous page)

1. Refer to the appropriate subsection(s) below for information on configuring the wired and/or wireless connection(s) between the TV and the network.

## Configure a Wired Network Connection



- a. If not already done, connect the appropriate cable between the TV and the network.
- b. Make sure the **Wired (Ethernet)** option is selected in the Network Connection Type field, and then press **OK** on the Installer Remote.
- c. By default, the TV uses DHCP, and if a LAN is detected, the TV will request an IP address from the DHCP server on the network. If the TV is able to connect to the network, the network configuration data will be displayed on the screen as shown in the example above.  
If the network is not configured for DHCP, or if you want to enable/disable IPv6 or specify static IP configuration data (applicable only for IPv4), continue with steps (d) and/or (e), respectively.
- d. (Optional) To enable IPv6, select/highlight the IPv6 field and press **OK**. Then, select **Enabled** from the drop-down list of options.
- e. (Optional / IPv4 only) If required, you can edit the IP data for this TV as follows:
  - De-select the “Automatically Assign IP Address” checkbox under “Advanced Options.”
  - For each data entry field: Use the arrow keys on the Installer Remote to select the field and press **OK**. You can use the number keys on the Installer Remote to direct enter numeric values or use the arrow keys to select the appropriate characters from the pop-up virtual keyboard displayed at the bottom of the screen. When you are done, select **Enter** from the virtual keyboard, and then press **OK** on the Installer Remote.

**Note:** You must use the dot “.” key from the virtual keyboard to separate each octet of an IP address.

(Continued on next page)

(Continued from previous page)

## Configure a Wireless (Wi-Fi) Network Connection

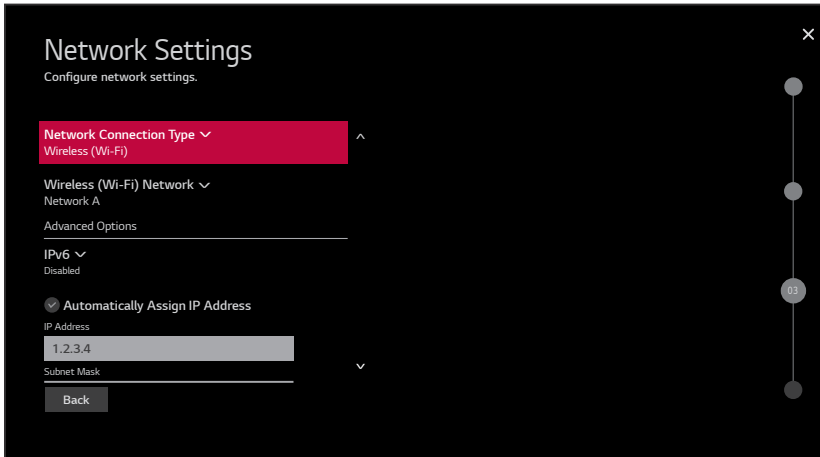

- a. Select/highlight the Network Connection Type field, and press **OK** on the Installer Remote. Then, use the Up/Down arrow keys to select/highlight **Wireless (Wi-Fi)**, and press **OK** once more.
- b. Select/highlight the Wireless (Wi-Fi) Network field, and press **OK** on the Installer Remote. Then, use the Up/Down arrow keys to select/highlight the desired access point from the drop-down list of available options, or select the “Hidden Network” option at the bottom of the list to specify an access point with a hidden SSID. Press **OK** once more.

**Note:** Make sure you have the network security password—at least eight, but no more than 32 characters—or PIN available if you are attempting to connect to a secured network. If you would like to add an access point with a hidden SSID, you will need to direct enter the SSID—up to 32 characters—of the access point.

- c. Follow the on-screen instructions to complete the appropriate network configuration. Use the Installer Remote to navigate between fields and make entries, etc.

**Note:** As with a wired connection, you will have the option to specify static IPv4 configuration data for this network connection. Once the initial connection is established, you can de-select the “Automatically Assign IP Address” checkbox under “Advanced Options,” and then modify the IP data, as required. See step (e) of the wired connection procedure above for further information on the data entry fields.

- d. (Optional) To enable IPv6, select/highlight the IPv6 field and press **OK**. Then, select **Enabled** from the drop-down list of options.
- e. Once the wireless network configuration is complete, Use the arrow keys on the Installer Remote to select **Connect**, and then press **OK** on the Installer Remote.

**Note:** The “Connect” button disappears once the connection is successful.

2. When you are ready to continue, use the arrow keys to select **Back**, and then press **OK** on the Installer Remote to return to the TV Configuration Options screen. Then, proceed as required from the TV Configuration Options screen.

# Advanced Settings / EZ-Manager Wizard (Cont.)

## Pro:Centric Settings

Once you select “Next” from the TV Configuration Options screen, the Configure Pro:Centric Server screen is displayed. Use the Up/Down arrow keys on the Installer Remote to select the appropriate option.

- If there is a Pro:Centric server installed on-site, select/highlight **Standard Pro:Centric Server Settings** and press **OK**. Then, select **Next**, and press **OK** once more. See “Standard Pro:Centric Server Configuration” on pages 48 to 52 to complete the Pro:Centric configuration.
- If you will be using LG’s Pro:Centric Cloud solution to configure the TVs at the site for Pro:Centric operation, select/highlight **LG Pro:Centric Cloud Settings** and press **OK**. Then, select **Next**, and press **OK** once more. See “Pro:Centric Cloud Server Configuration” on page 53 to complete the Pro:Centric configuration.

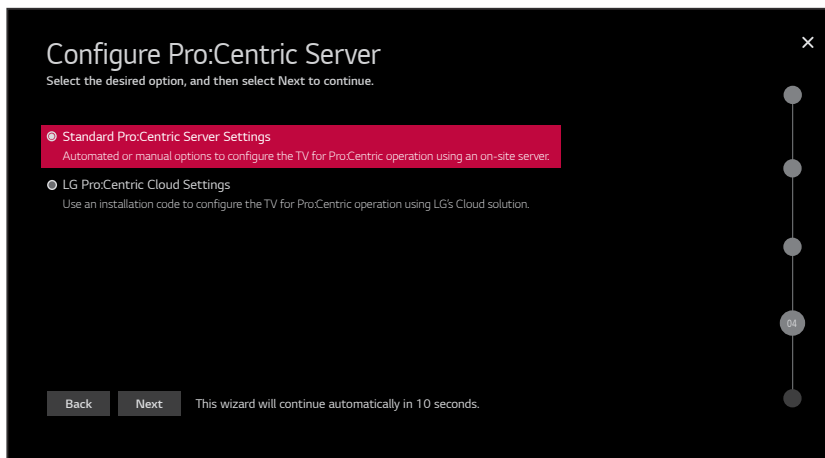

## Standard Pro:Centric Server Configuration

This section describes options for completing Pro:Centric configuration when a server is installed on-site.

**Note:** See “Pro:Centric Cloud Server Configuration” on page 53 for information on Pro:Centric configuration with LG’s Pro:Centric Cloud solution.

Once you select the “Standard Pro:Centric Server Settings” option in the Configure Pro:Centric Server screen, the Searching for Pro:Centric Server screen is displayed (see example on following page).

- You can allow the EZ-Manager Wizard to proceed with a series of automated steps to configure the TV for Pro:Centric operation and then to look for the Pro:Centric application and maintenance (E-Z Installation) files to download. In this case, the wizard uses a search algorithm to determine the Data Channel and the Pro:Centric Application Mode to set in the TV.

Continue with the “Automated Pro:Centric Configuration” subsection below.

- If you already know the settings (e.g., Data Channel and Pro:Centric Application Mode) that need to be configured in order for the TV to connect to the Pro:Centric server and/or if the Pro:Centric server is not yet installed, you may expedite the setup process by entering this data manually.

Continue with the “Manual Pro:Centric Configuration” subsection on page 50.

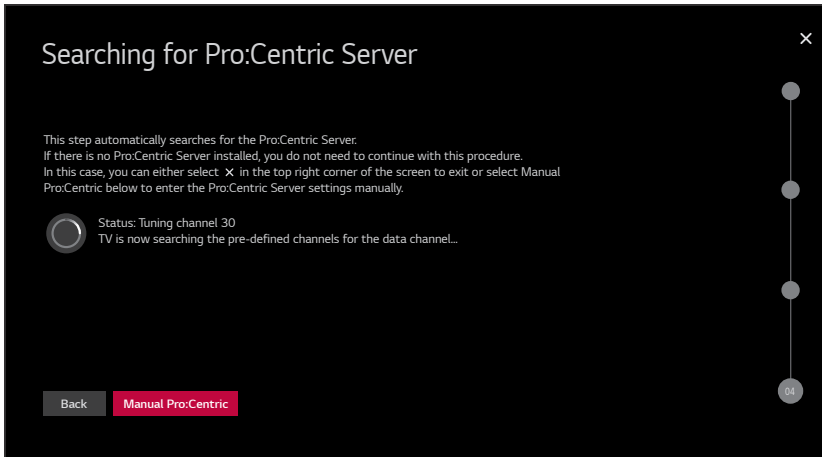

## Automated Pro:Centric Configuration

**Note:** If the server is not yet configured on the system or if Pro:Centric data delivery will be over IP and there is no Domain Name System (DNS) server, use the manual configuration option to configure the TV's Pro:Centric server settings (see "Manual Pro:Centric Configuration" on page 50). See also note below regarding DNS requirements.

**Note:** If there is a DNS server at the site, you can create a "procentric.local" DNS entry with the Pro:Centric server's IP address. Also, the Pro:Centric server's port number must be set to "80" to allow the automated Pro:Centric IP configuration via the EZ-Manager to find the server.

Once the Pro:Centric data channel is found (a Pro:Centric Server Was Found screen will be displayed) and the Pro:Centric Application Mode is determined, the wizard will advance to a Processing the Pro:Centric Configuration screen, which shows the progress of the data downloads. Note that some steps may require a few minutes.

If the process is successful, no further user interaction is required, though, in some instances, where the option (for example, "Next") is available, you may manually move forward to subsequent steps within the wizard to speed up the process.

**Note:** If, after completing the search, the TV is unable to find the Pro:Centric data channel (while the Searching for Pro:Centric Server screen is on display), the wizard will stop and show a Diagnostics screen that enables you to manually return to the previous screen (to reinitiate the configuration) or exit the wizard.

When the Pro:Centric Configuration is complete, an EZ-Manager Configuration Complete screen is displayed (see example below), and after 10 seconds, the wizard exits, and the TV turns OFF.

**Note:** With the EZ-Manager Configuration Complete screen on display, you can also manually turn off or reboot the TV. If desired, select **Turn Off** or **Reboot**, respectively, and then press **OK** on the Installer Remote.

(Continued on next page)

# Advanced Settings / EZ-Manager Wizard (Cont.)

(Continued from previous page)

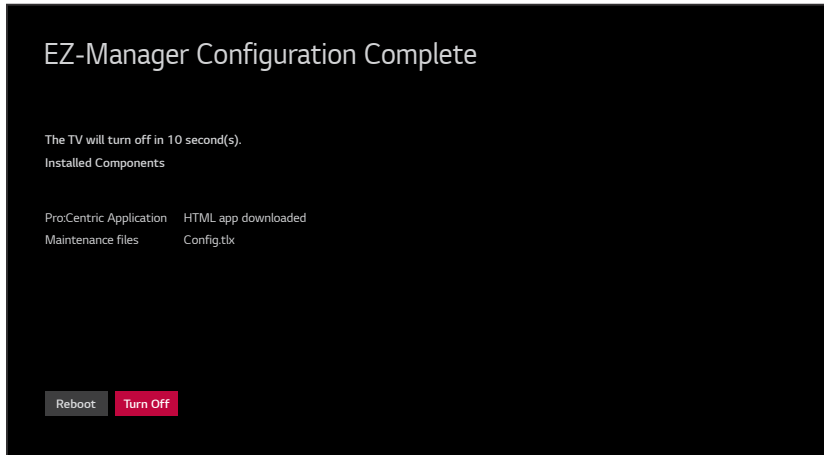

## Manual Pro:Centric Configuration

1. With the Searching for Pro:Centric Server screen on display, use the Left/Right arrow keys on the Installer Remote to select **Manual Pro:Centric** at the bottom of the screen, and then press **OK**.

In the Pro:Centric Manual Configuration screen (see examples below), you will be able to configure the appropriate Pro:Centric settings in the TV. Use the Up/Down arrow keys on the Installer Remote to navigate between fields.

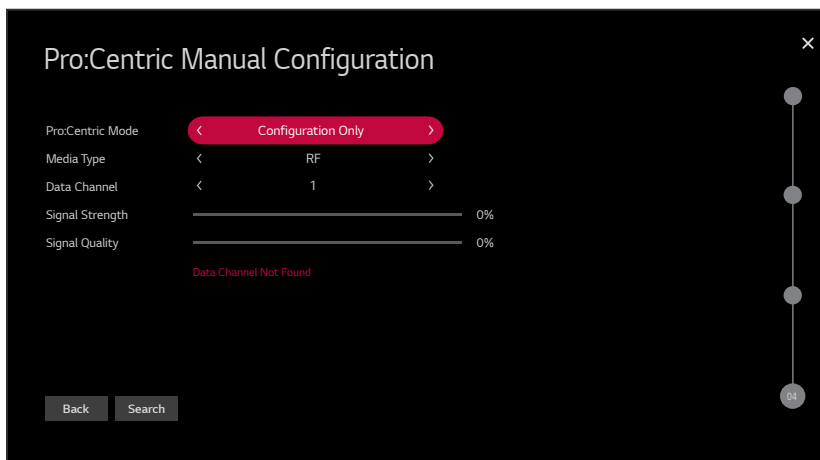

Pro:Centric Manual Configuration Screen with RF Media Fields

**Note:** By default, the Pro:Centric Manual Configuration screen initially shows RF configuration fields.

(Continued on next page)

(Continued from previous page)

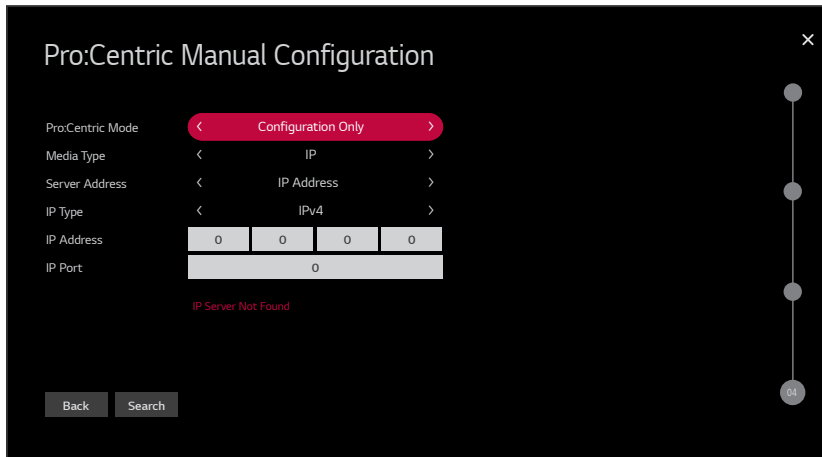

Pro:Centric Manual Configuration Screen with IP Media Fields

2. In the Pro:Centric Mode field, use the Left/Right arrow keys to select the appropriate Pro:Centric Application Mode—**GEM** (Java), **HTML**, or **Configuration Only**.

**Note:** For remote management only, select **Configuration Only**. The TV will search for TV E-Z Installation data downloads; however, Pro:Centric application data will not be downloaded, i.e., Installer Menu item 098 PRO:CENTRIC will be set to 0.

3. Refer to the appropriate subsection below, depending on the Pro:Centric server configuration, to complete the remaining fields.

### *RF Configuration*

- a) In the Media Type field, use the Left/Right arrow keys to select **RF**.
- b) In the Data Channel field, use the Left/Right arrow keys to select the RF channel number that will be used by the Pro:Centric server as its data channel. The Data Channel value can be set from 1 to 135.\*

### *IP Configuration*

- a) In the Media Type field, use the Left/Right arrow keys to select **IP**.  
**Note:** When you select “IP” as the Media Type, the default RF Data Channel and Signal Strength/Quality fields are replaced with Server Address, IP Type, IP Address, and IP Port fields.
- b) The Server Address field provides the option to specify the domain name of the Pro:Centric server instead of the server’s IP address. Use the Left/Right arrow keys to select the desired option—IP Address or Domain Name—for defining the server.

(Continued on next page)

\* PCS150R and later Pro:Centric servers do not support HRC or IRC cable channel frequencies.



## Advanced Settings / EZ-Manager Wizard (Cont.)

---

(Continued from previous page)

- c) Depending on your selection in the previous step, either:
- Select the appropriate IP type (either IPv4 or IPv6) in the IP Type field, and then enter the Pro:Centric server IP address in the IP Address field. The IP address must match the IPv4 or IPv6 (as applicable) address that is set in the Pro:Centric server.
  - Enter the Pro:Centric server domain name—up to 63 characters (no spaces allowed)—in the Domain Name field. Note that in order for the domain name to be resolved to an IP address, there must be a DNS entry for the domain name.

For each data entry field: Use the arrow keys to select the field and press **OK**. Then, you can either use the number keys on the Installer Remote to direct enter data values, or you can use the arrow keys to select the appropriate number(s)/alphanumeric character(s) from the pop-up virtual keyboard displayed at the bottom of the screen. When you are done, select **Enter** from the virtual keyboard, and then press **OK** on the Installer Remote.

**Note:** For an IPv6 IP address, you must use the colon “:” key from the virtual keyboard to separate each group.

- d) Enter the Pro:Centric server port number in the IP Port field. The port number must match the port number that is set in the Pro:Centric server.

4. Once all fields are completed as required, you have two options:

- To save the data entered and exit the wizard, use the arrow keys to select the **✕** button at the top right of the screen, and then press **OK**. In the subsequent pop-up confirmation window, select **Save & Exit**, and then press **OK** once more. The Pro:Centric application and/or E-Z Installation data will be downloaded to the TV at a later time. This option is useful, in particular, if the Pro:Centric server has not yet been configured.
- To initiate a real-time download of Pro:Centric application and/or E-Z Installation data, use the arrow keys to select **Search** and press **OK** to verify the configuration data provided in step 3. When the data is verified, the “Search” button becomes a “Next” button. Select **Next** and press **OK** to continue (see also note below).

**Note:** With RF configuration, Pro:Centric server data must be present on the RF channel selected as the TV’s Data Channel in order for you to select “Next” (you will see a “Data Channel Found” message below the Signal Quality indicator). With IP configuration, Pro:Centric server data must be present via the wired LAN cable connection in order for you to select “Next” (you will see a “IP Server Found” message below the IP Port field).

If you opt to initiate a real-time download in the last step, the EZ-Manager Wizard will proceed with the Pro:Centric application and/or E-Z Installation data downloads (you will see a Processing the Pro:Centric Configuration screen). When the Pro:Centric configuration is complete, an EZ-Manager Configuration Complete screen (see example on page 50) is displayed, and after 10 seconds, the wizard exits, and the TV turns OFF.

**Note:** With the EZ-Manager Configuration Complete screen on display, you can also manually turn off or reboot the TV. If desired, select **Turn Off** or **Reboot**, respectively, and then press **OK** on the Installer Remote.

### Pro:Centric Cloud Server Configuration

This section describes how to complete the TV's Pro:Centric configuration when the (virtual) server is configured on LG's Pro:Centric Cloud portal (applicable only with CPU v4.41.00 or later and PTC v1.00.011 or later). You will need the six-digit installation code for this property in order to set up the Pro:Centric Cloud server configuration.

**Note:** The installation code is generated in the Pro:Centric Cloud portal. A user with an Administrator role for this property must provide/generate the code. The procedure below also assumes this property has already been added to the Pro:Centric Cloud portal. Refer to the **Pro:Centric Cloud Portal User Guide** for further information.

**Note:** See "Standard Pro:Centric Server Configuration" on pages 48 to 52 for information on Pro:Centric configuration when a server is installed on-site.

Once you select the "LG Pro:Centric Cloud Settings" option in the Configure Pro:Centric Server screen, the Pro:Centric Cloud Configuration screen is displayed (see example below). Complete the steps below to connect the TV to the Pro:Centric Cloud server.

1. Enter the six-digit installation code in the Installation Code field.

Use the arrow keys to select the field, if necessary, and press **OK**. Then, you can either use the number keys on the Installer Remote to direct enter the installation code, or you can use the arrow keys to select the appropriate numbers from the pop-up virtual keyboard displayed on the screen.

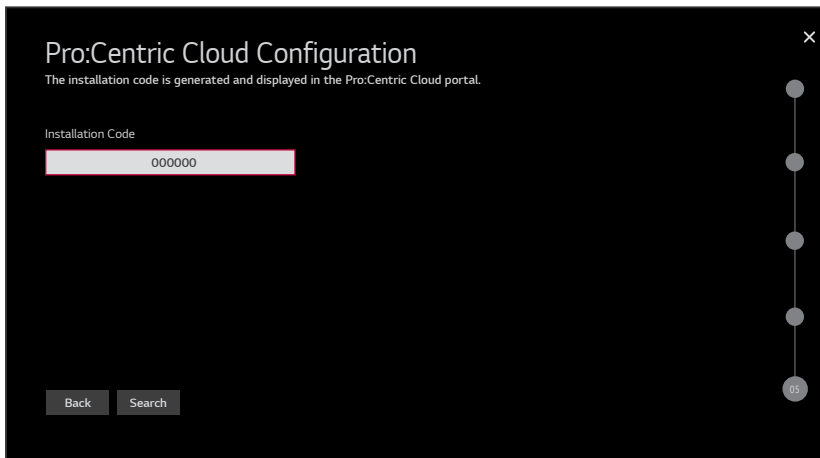

2. Use the arrow keys to select **Search** and press **OK** to verify the installation code. When the installation code is verified, the "Search" button becomes a "Next" button (you also will see a "Server Found" message below the Installation Code field). Select **Next** and press **OK** to continue.

Once the installation code is verified and you continue, the EZ-Manager Wizard will proceed with the Pro:Centric application download (you will see a Processing the Pro:Centric Configuration screen). When the Pro:Centric configuration is complete, an EZ-Manager Configuration Complete screen is displayed (see example on page 50, though note that a list of installed components will not be displayed), and after 10 seconds, the wizard exits, and the TV turns OFF.

**Note:** With the EZ-Manager Configuration Complete screen on display, you can also manually turn off or reboot the TV. If desired, select **Turn Off** or **Reboot**, respectively, and then press **OK** on the Installer Remote.

# Advanced Settings / EZ-Manager Wizard (Cont.)

---

## USB Configuration

TV Manager / USB download options enable you to download configuration, image, video, or software files from a USB memory device to the TV. You can also use the Ez Download utility available from the menu to select multiple types of files to be downloaded at one time using one process.

Each of the USB download functions requires that you have the appropriate file(s) loaded on a USB memory device. If you wish to perform a software update or download image/icon/video files, the applicable file(s) must be stored in a folder named “LG\_DTV” in the root directory of the USB device. Clone/Configuration (.tlx) files should simply be stored in the root directory of the USB device.

**Note:** If appropriate, you may download a Pro:Idiom Media Key (.pim) file via the Ez Download utility. The “.pim” file must be stored in a folder named “LG\_DTV” in the root directory of the USB memory device. See Reference section, “Downloading a Pro:Idiom Media Key using a USB Memory Device,” for further information on file requirements.

The procedure below assumes the desired file(s) is/are already loaded onto the USB device. For further information on the TV Manager / USB download options and file requirements, and/or for information on creating Clone/Configuration (.tlx) files, refer to the appropriate section(s) in this document.

### Before You Begin

- If you intend to use the Zoning feature(s) on this TV, make sure to set the appropriate TV Zone # and/or Wi-Fi Zone # in the EZ-Manager’s Zones, Label, and Room Number screen BEFORE continuing with USB Configuration. See also “TV Configuration Options” on page 43.  
**Note:** The TV Zoning feature is only available when Installer Menu item 027 HOSPITAL MODE is set to 0 (i.e., Hospital Mode is disabled). See item 027 description on page 68 for further details.
- Ensure the USB device to be used has been formatted with FAT format.
- When creating files to be downloaded, avoid using special characters (?, &, @, etc.) in filenames.
- Refer to “Ez Download Utility” on pages 56 to 60 for further information on the Ez Download utility.
- Refer to “Custom Master TV Setup” on pages 75 to 78 for information on creating a Clone (.tlx) file, and/or refer to “Creating an FTG Configuration File” on pages 86 to 88 for information on creating an FTG Configuration (.tlx) file for FTG Mode via CPU configuration.
- See Reference section, “Downloading Images or Icons using a USB Memory Device,” for image and icon guidelines.
- See Reference section, “Downloading a Hotel (Hospital) Video using a USB Memory Device,” for video guidelines.
- See Reference section, “Updating TV/PTC Software using a USB Memory Device,” for further information on software updates.

### USB Configuration via EZ-Manager Wizard

With either the TV Configuration Options or the Zones, Label, and Room Number screen on display, proceed as follows to configure the TV using the USB memory device.

1. Insert the USB memory device with the appropriate file(s) into either of the TV’s USB ports.

(Continued on next page)

## Advanced Settings / EZ-Manager Wizard (Cont.)

(Continued from previous page)

2. Use the arrow keys on the Installer Remote to select **USB Configuration**, and then press **OK**.

You will be redirected to the TV Manager / USB download options.

**Note:** You can select the **✕** button at the top right corner of the screen and press **OK** on the Installer Remote at any time to return to the EZ-Manager Wizard.

**Note:** Ez Download is always selected by default when you initially access the TV Manager. Also note that Diagnostics is for service use only.

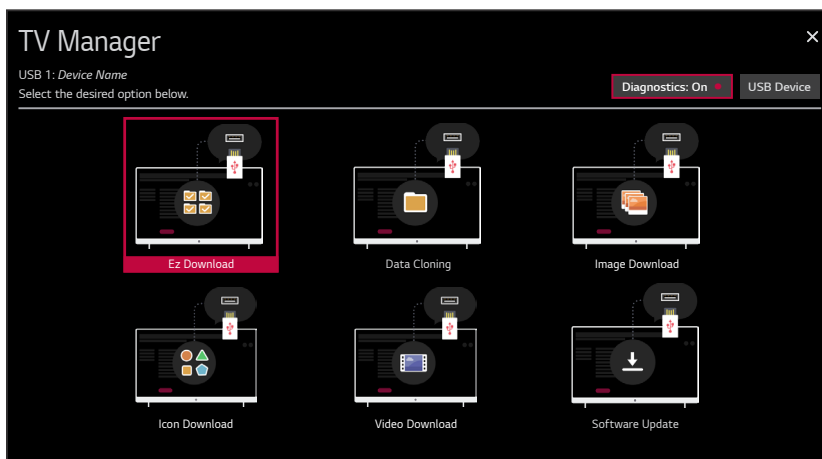

3. If more than one USB memory device is currently connected to the TV, be sure to select the USB device that contains the file(s) you wish to use. If necessary, use the arrow keys on the Installer Remote to select/highlight the **USB Device** button at the top right of the screen and press **OK**. Then, use the Up/Down arrow keys to select the appropriate USB device from the pop-up list of USB devices.
4. Select the appropriate option from the TV Manager, and initiate the desired download(s)/update(s).

Download/update progress will be displayed on the screen. Do NOT remove the USB device while downloads/updates are in progress. When the process is complete, the TV will reboot. Upon restart, depending on the type of download(s)/update(s) completed, either the EZ-Manager TV Configuration Options screen will be redisplayed (image, video, and/or software downloads/updates only) or the TV will tune according to the Start Channel setting in the Installer Menu (TV configured with Clone/Configuration file).

**Note:** If the TV Configuration Options screen is redisplayed (image, video, and/or software downloads/updates only), you can either proceed with configuration via the EZ-Manager Wizard or exit the EZ-Manager Wizard, as required.

5. Remove the USB memory device, and verify that the appropriate configuration/download(s)/update(s) is/are resident on the TV.

# Ez Download Utility

---

The Ez Download utility, available from the TV Manager, enables you to select multiple files at one time from the files loaded on a USB memory device. You may use this utility to download any one or all of the following to a TV:

- One Clone or FTG Configuration (.tlx) file
- One TV CPU software update
- One PTC software update
- One Pro:Idiom Media Key (.pim) file
- One boot logo image
- Up to 12 (or 10 MB) application background images
- Up to 12 (or 10 MB) images for each hospital directory in a customized portal
- One hospital icon for a customized portal
- One icon for each website shortcut in a customized portal
- One hospital video for a customized portal

## Before You Begin

- Ensure the USB device has been formatted with FAT format.
- Software update, image/icon, video, and Pro:Idiom Media Key files must be stored in a folder named “LG\_DTV” in the root directory of the USB memory device. Clone/Configuration (.tlx) files should simply be stored in the root directory of the USB device.
- If you have initiated the EZ-Manager Wizard, you can use the wizard’s “USB Configuration” option to access the Ez Download utility, if desired (see “TV Configuration Options” and/or “USB Configuration” on pages 43 and 54, respectively, as necessary).
- If the TV is currently in Pass-through Mode and you intend to use the Zoning feature(s) on this TV for location-specific configuration purposes, make sure to set the appropriate TV Zone # and/or Wi-Fi Zone # in the TV when directed to do so in the procedure below.

**Note:** The TV Zoning feature is only available when Installer Menu item 027 HOSPITAL MODE is set to 0 (i.e., Hospital Mode is disabled). See item 027 description on page 68 for further details.

- When creating files to be downloaded, avoid using special characters (?, &, @, etc.) in filenames.
- Refer to “Custom Master TV Setup” on pages 75 to 78 for information on creating a Clone (.tlx) file, and/or refer to “Creating an FTG Configuration File” on pages 86 to 88 for information on creating an FTG Configuration (.tlx) file for FTG Mode via CPU configuration.
- See Reference section, “Downloading Images or Icons using a USB Memory Device,” for image and icon guidelines.
- See Reference section, “Downloading a Hotel (Hospital) Video using a USB Memory Device,” for video guidelines.
- See Reference section, “Updating TV/PTC Software using a USB Memory Device,” for further information on software updates.
- See Reference section, “Downloading a Pro:Idiom Media Key using a USB Memory Device,” for further information on file requirements.



**Caution: Do not unplug the TV power cord or remove the USB memory device during a data download, as doing so may cause the TV to malfunction or harm the USB device, respectively.**

## Accessing and Using the Ez Download Utility

1. If it is not ON already, turn ON the TV.
2. The next step depends on whether the First Use Wizard appears on the screen when you turn ON the TV:
  - If the wizard is displayed, you can access the Ez Download utility via the EZ-Manager Wizard, as indicated above (see “Before You Begin”). However, to continue with this procedure and access the Ez Download utility from the TV menus, exit the First Use Wizard. Then, continue with step 3.
  - If the wizard is not displayed, go directly to step 3.
3. If the TV is currently in Pass-through Mode, you would like to transfer (import) a “.tlx” file to the TV via the Ez Download utility, and you intend to use one or both of the TV’s Zoning feature(s), set the appropriate TV Zone # and/or Wi-Fi Zone # in the TV at this time. See Reference section, “Using the TV’s Zoning Features,” for further information.



**Note: In order for the proper TV Zone and/or Wi-Fi Zone profile data to be applied, the appropriate TV Zone # and/or Wi-Fi Zone # must be set in the Target TV BEFORE you continue with the Ez Download utility.**

4. Insert the USB memory device with the appropriate file(s) into either of the TV’s USB ports.
5. To access the TV Manager from the TV menus:
  - Press **MENU** on the Installer Remote to display the TV setup menus (TV is in Pass-through Mode) or the Function Menu (TV is not in Pass-through Mode).
  - If the Quick Settings Menu is displayed at the left of the screen (i.e., the TV is in Pass-through Mode), select the **All Settings**  menu icon and press **OK** to access the advanced TV setup menus.
  - Use the arrow navigation keys to select/highlight either the **General** menu icon from the TV setup menus or the **Safety** menu icon from the Function Menu. Then, press the number “7” key a total of seven times.
  - If a password prompt is displayed (i.e., TV Manager Password Protection is enabled in the IP Environment / General Menu), key in the TV Manager password and press **OK**.

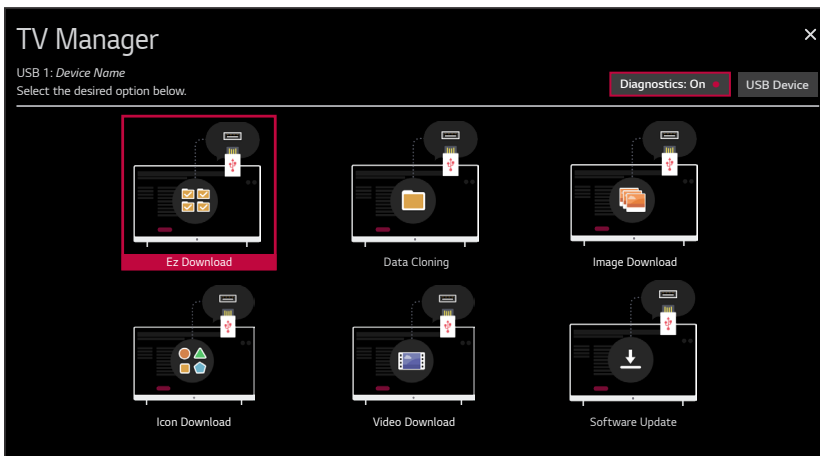

(Continued on next page)

## Ez Download Utility (Cont.)

(Continued from previous page)

**Note:** Ez Download is always selected by default when you initially access the TV Manager. Also note that Diagnostics is for service use only.

- If more than one USB memory device is currently connected to the TV, be sure to select the USB device that contains the file(s) you wish to use. If necessary, use the arrow keys on the Installer Remote to select/highlight the **USB Device** button at the top right of the screen and press **OK**. Then, use the Up/Down arrow keys to select the appropriate USB device from the pop-up list of USB devices.



- If it is not currently selected, use the arrow keys to select **Ez Download**, and then press **OK**.

In the Ez Download screen, a list of files/file types is displayed on the left. Remember that image/icon/video, Pro:Idiom Media Key, TV software (CPU), and PTC software files must be stored in the LG\_DTV folder and Clone/Configuration (.tlx) files must be stored in the root directory on the USB device.

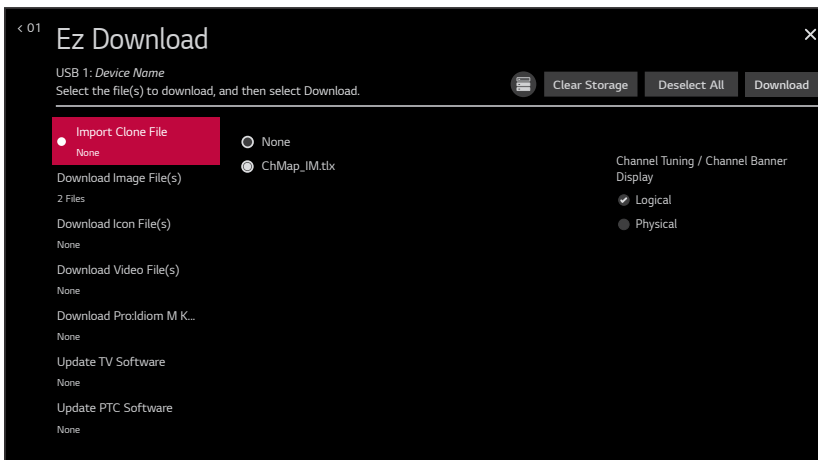

**Note:** Select the **X** button in the top right corner of the screen, as necessary, to exit the TV Manager. If you accessed the TV Manager via the Advanced Settings / EZ-Manager Wizard, you will be returned to the last screen on display before you selected the "USB Configuration" option. If you accessed the TV Manager via the TV menus, you will be returned to program viewing. You can also return/navigate to the TV Manager main screen by selecting **< 01** in the top left corner of the Ez Download screen.

**Note:** The "Download Pro:Idiom M Key" option only appears if a ".pim" file is detected on the USB device.

(Continued on next page)



(Continued from previous page)

8. To select a file:

- Use the arrow keys on the Installer Remote to select/highlight the appropriate file type field, and then press **OK**.

A list of available files is displayed to the right of the file type fields. In the case of image/icon/video files, once you select the initial “Download Image File(s)” or “Download Icon File(s)” or “Download Video File(s)” option, you will need to also select the appropriate type of image/icon/video file (boot logo image, background image, etc.) before selecting the image/icon/video file(s) itself/themselves.

- Then, use the arrow keys to select the desired file(s).

**Note:** With the exception of background and hospital directory image files, the utility will only allow you to select one of each file type for downloading. For example, if there are two files in the Ez Download “Import Clone File” list, you can only select one or the other of those files.

**Note:** The initial default value for each file type is “None.” After the Ez Download utility is run, a file is automatically created and stored on the USB device that was used. The file, which will have a “.dzm” file extension, maintains a history of the file(s) previously used with the Ez Download utility. The next time(s) you use this USB device with the Ez Download utility, the file(s) selected for the last download will be pre-selected for the current download, thus facilitating the process of configuring additional TVs of this model using the same USB device. If you ever want to restore the file selections on the Ez Download screen to “None,” select the **Deselect All** button and press **OK**.

**Note:** The current TV software (CPU) or PTC software version is always displayed above the listing of available TV software and PTC software files, respectively. Ensure the software version of the selected file is the correct version before applying the update to this TV.

**Note:** You can select the  (Storage) button at the top of the Ez Download screen to check the amount of storage available for and currently in use by media (image, icon, and video) files. Storage data will be displayed in a pop-up window. When you are finished, select **OK** to close the pop-up window. If you would like to clear all of the media files currently in storage, select the **Clear Storage** button. Then, in the confirmation pop-up window, select **Yes** to clear all of the media files, or select **No** to return to the Ez Download screen without clearing the media files.

9. If a Clone/Configuration (.tx) file that includes an FTG Channel Map is selected, a Channel Tuning / Channel Banner Display field will be displayed at the right of the screen. If the FTG Channel Map comprises RF channels and Aux inputs *only* (the latter designated by 130-0 through 137-0), you can choose the format for the channel tuning/banner display. Use the arrow keys on the Installer Remote to select **Logical** tuning or **Physical** tuning. A checkmark will appear at the left of the selected option. Logical tuning is selected by default.

**Note:** If an FTG Channel Map includes IP channels, only logical tuning is available. Also, if the selected “.tx” file does not include an FTG Channel Map, the message, “No Channel Map in Clone file,” will be displayed at the right of the screen.

(Continued on next page)

## Ez Download Utility (Cont.)

---

(Continued from previous page)

10. When you are ready to continue, use the arrow keys on the Installer Remote to select **Download**, and then press **OK**.

Download/update progress will be displayed on the screen. Do NOT remove the USB device while downloads/updates are in progress. When the Ez Download process is complete, an overview of the results will briefly be displayed and then, the TV will reboot.

11. Remove the USB memory device, and verify that the appropriate configuration/download(s)/update(s) is/are resident on the TV.

**Note:** If you updated the TV configuration with a Clone/Configuration file, upon restart, the TV tunes according to the Start Channel setting in the Installer Menu. If a Start Channel is specified, the TV will tune to that channel, though in the case of FTG Mode via CPU configuration, a channel banner will only be displayed if the Start Channel is included in the FTG Channel Map (depending on your selection in step 9, the channel banner will display either the Start Channel's logical channel number or physical RF channel number). Otherwise, the TV will either return to the last channel tuned (TV in Pass-through Mode) or tune to the first channel in the FTG Channel Map (TV in FTG Mode via CPU). In the latter case, remember that the channels in the FTG Channel Map are always arranged in logical order, regardless of your selection in step 9.

Use the Installer Menu to set up, change, or view operational settings. This section describes how to access, use, and exit the Installer Menu from the TV itself. However, you should also refer to the Installer Menu descriptions in this document if you are configuring the TV CPU using an FTG Configuration (.tlx) file created using LG's Cloud Configuration Tool or configuring the EBL locally (.rml) or remotely (via FMA-LG102 / .fma) using the FTG Device Configuration Application software.

Refer to the table on pages 63 to 65 for brief descriptions of Installer Menu items. More detailed descriptions follow the table listing.

## Accessing the Installer Menu

1. Turn ON the TV.

If the First Use Wizard appears on the screen when you turn ON the TV, exit the wizard.

2. Using an Installer Remote, press **MENU** repeatedly until the on-screen display of the TV setup menus (if the TV is in Pass-through Mode) or the Function Menu (if the TV is not in Pass-through Mode) no longer toggles, and then press the Installer Menu entry sequence (e.g., **9-8-7-6**) + **OK** to access the Installer Menu.

**Note:** The default Installer Menu entry sequence is "9876"; however, if Installer Menu item 000 INSTALLER SEQUENCE has been modified, the entry sequence may be one of three additional options. See Installer Menu detailed descriptions for further information.

The Installer Menu opens with item 000 INSTALLER SEQ 000.

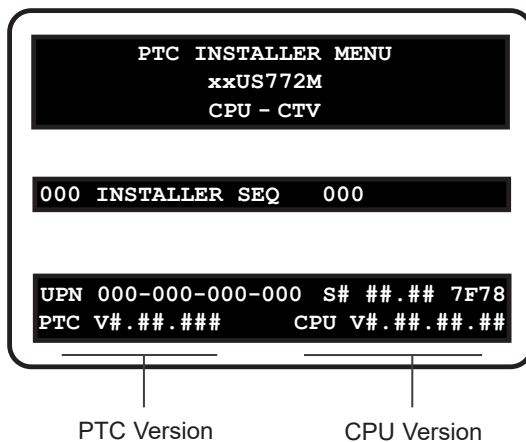

### Typical Installer Menu

The Installer Menu header will vary depending on the TV you are setting up. In the Installer Menu footer, you can see the current software versions of the TV, as indicated.

**Note:** If the password (entry sequence) is not entered or registered correctly, you will see the message "ENTER PASSWORD 0000" at the top of the screen instead of the Installer Menu header. Once you re-enter the correct password (e.g., press 9-8-7-6 + OK), the Installer Menu will display.

**Note:** If the TV is not in Pass-through Mode, the Installer Menu is accessible as read-only. Also, the TV Zone # will be indicated in the Installer Menu header under the configuration mode indicator described below.

## Installer Menu (Cont.)

---

As part of the Installer Menu header (in all modes), two 3-character acronyms are displayed to indicate the TV's current configuration mode. The table below lists all possible mode identifiers for these TV models.

Acronym	Description
CPU-CTV	(Default) Pass-through Mode with or without Channel Lineup in CPU
CPU-FTG	FTG Mode via CPU
CPU-P:C	Application Tuning Mode via CPU
EBL-FTG	FTG Mode via EBL
EBL-LNT	SONIFI PPV Mode
MPI-EXT	External MPI Control
PTC-CTV	Pass-through Mode with Channel Map in PTC

### Navigating Within the Installer Menu

Use the Up/Down arrow keys on the Installer Remote to sequence through the available menu items, or access an item directly by keying in the item number and then pressing **MENU**. For example, to access the SLEEP TIMER option, which is item 015, press 0-1-5 + MENU.

Installer Menu items not relevant to these TV models are not present in the Installer Menu; therefore, some numbers are missing. For example, item 006 will not appear. In addition, items that are dependent on other Installer Menu item settings will not be initially accessible. For example, item 046 STRT AUX SRCE will not display in the Installer Menu unless item 004 STRT CHANNEL is set to 0. See Installer Menu detailed descriptions for further information.

### Modifying Installer Menu Settings

Refer to the table starting on the next page for an overview of the available Installer Menu items, including their item numbers, functions, value ranges, and default values.

To change an Installer Menu item value, use the Left/Right arrow keys on the Installer Remote to select the appropriate value, or direct enter a valid value. To save the new setting, press **OK** once on the Installer Remote. If you have additional items to modify, use the Up/Down arrow keys to navigate to a new Installer Menu item or access an item directly as described in the previous section. Note that invalid values will not be saved.



**Caution:** In order for Installer Menu item changes to be saved, you must press **OK** as indicated above and then exit the Installer Menu as described below. Never remove power from the TV while in the Installer Menu. Also, remember that Installer Menu settings may affect options available from the TV setup menus or the Function Menu.

### Exiting the Installer Menu and Activating Settings

After you have saved all desired Installer Menu item changes (i.e., press **OK** once on the Installer Remote to save changes), press **OK** again to exit the Installer Menu. Any changes you make will be stored in non-volatile memory.

**Note:** Each time you exit the Installer Menu in Pass-through Mode, all V-Chip (Parental Control) settings in the TV are reset to their default values; that is, the Lock System, if previously enabled from the Safety Menu, will now be disabled, and the individual Parental Control settings will be restored to default values.

## Installer Menu Items 000 through 032

Item	Function	Value Range	Default Value	Brief Description of Function
000	INSTALLER SEQ	0–3	0	Leave default set to 0.
001	POWER MANAGE	0–15*	0	Selects the number of hours of inactivity allowed before the TV automatically turns itself OFF and also determines the availability of the Force TV Reboot with IR Remote feature. See detailed descriptions.
002	AC ON	0–3, 16–19	0	Determines the status of the TV (ON, Instant ON enabled, etc.) when AC power is applied. See detailed descriptions.
003	BAND/AFC	0–3	1	Selects the RF Tuning Band: 0=Broadcast, 1=Cable, 2=HRC, 3=IRC
004	STRT CHANNEL	0–127, 253, 255	255	Channel tuned when the TV is turned ON. (Set to 255 to tune to channel tuned before the TV was turned OFF.)
005	CHAN LOCK	0 / 1	0	If set to 1, cannot tune from current channel.
007	STRT VOLUME	0–63, 255	255	Volume level when the TV is turned ON. (Set to 255 to use volume level set before the TV was turned OFF.)
008	MIN VOLUME	0–63	0	Sets the minimum allowable volume setting.
009	MAX VOLUME	0–63	63	Sets the maximum allowable volume setting.
010	MUTE DISABLE	0–3**	0	Determines the status of the sound Mute function and the visibility of the Volume Mute icon. See detailed descriptions.
012	IR BANKS EN.	0 / 1	0	Set to 1 to enable the TV to respond to bank discrete IR codes.
013	SCAN MODE	0 / 1	0	Set to 1 to allow Channel Up/Down key presses to turn ON the TV. See detailed descriptions.
014	STRT CH IN SM	0 / 1	0	Set to 1 to use the Start Channel for the Channel Map pivot point in Scan Mode.
015	SLEEP TIMER	0 / 1	1	Set to 1 to enable the Sleep Timer feature.
016	EN. TIMER	0 / 1	1	Set to 1 to enable On/Off timers.
017	ALARM	0 / 1	1	Set to 1 to enable the Alarm feature in the Function Menu.
020	FEATURE LEVEL	0–3, 16–31, 64–67†	1	Determines an additional IR code scheme to which the TV will respond. See detailed descriptions.
021	V-CHIP	0 / 1	1	Set to 1 to enable V-Chip (Parental Control) functions.
022	MAX BLK HRS	0–99	12	Determines the number of Parental Control blocking hours that can be set in the Function Menu.
023	POWER ON CC	0–2‡	0	Set to 1 to retain the closed caption setting selected before the TV was turned OFF. Set to 2 to specify closed caption settings, for both analog and digital channels, when the TV is turned ON.
025	FUNCTION PRE.	0 / 1	1	Set to 1 to allow Channel Preview/Banks Setup Menu access.
027	HOSPITAL MODE	0–162, 254	254	Set according to the speaker selection, the pillow speaker IR scheme/supply voltage, and/or the hospital remote IR scheme. See detailed instructions.
028	CH. OVERRIDE	0 / 1	1	If set to 0, end users can only tune to channels that are included in the PTC Channel Map. See detailed descriptions.
029	REMAP AUX INPS	0 / 1	0	Set to 1 to remap the PTC's direct tune channels for Aux inputs from 13x to 9x.
030	EXTCTL/ACKMASK	0–5‡	0	Enables/disables the ACK Mask feature of MPI and depending on mode, allows external control. See detailed descriptions.
031	POLL RATE	20–169	94	Selects the poll rate for MPI.
032	TIMING PULSE	186–227	207	Sets the baud rate for MPI.

\* Values 8 to 15 applicable with PTC v1.00.029 or later.

\*\* Values 2 & 3 applicable with CPU v4.43.50 or later and PTC v1.00.014 or later.

† Values 25 to 31 applicable with PTC v1.00.011 or later; values 2 & 66 applicable with PTC v1.00.13 or later; and values 3 & 67 applicable with PTC v1.00.25 or later.

‡ Formerly CAPTION LOCK. Value 2 applicable with PTC v1.00.014 or later.

‡ Values 2 to 5 (Ext Ctrl) applicable with CPU v4.46.60 or later and PTC v1.00.20 or later.

# Installer Menu (Cont.)

## Installer Menu Items 035 through 101

Item	Function	Value Range	Default Value	Brief Description of Function
035	HDMI1 ENABLE	0–2	1	Set to 0 to disable HDMI 1. Set to 1 (DTV Mode) or 2 (PC Mode), as applicable, to enable HDMI 1.
041	SIMPLINK EN	0 / 1	0	Determines the status of the SIMPLINK feature. See detailed descriptions.
042	AUTO INPUTS	0–255	0	Determines the Aux inputs for which auto-sensing is enabled. See detailed descriptions.
046	STRT AUX SRCE	3, 5, 255	255	Sets the starting Aux source (if item 004 STRT CHANNEL is set to 0).
047	AUX STATUS	0 / 1	0	Controls the MPI status channel response for Aux sources. Set to 1 for the Aux source to be reported as its channel number.
049	DIS. AUDIO M.	0–11, 16, 17	0	Determines the availability of the Sound Out (Audio) Menu in the TV menus, as well as the default Audio Mode when the TV is turned ON. See detailed descriptions.
053	DIS. CH-TIME	0 / 1	0	Set to 1 to disable display of the TV's native Channel-Time banner.
069	EN. CH-T COL.	0 / 1	1	Set to 1 to enable custom color for MPI display characters.
070	FOR. CH-TIME	0–7	2	Chooses custom foreground color for MPI display characters.
071	BCK. CH-TIME	0–7	2	Chooses custom background color for MPI display characters.
073	CH NOT AVBLE	0 / 1	0	If set to 1 and item 028 CH. OVERRIDE is set to 0, a "CHANNEL NOT AVAILABLE" message is displayed if the end user attempts to direct tune a channel that is not included in the channel lineup.
075	REVERT CH	0 / 1	0	If set to 1 and loss of MPI communication occurs, the TV tunes to the Start Channel.
077	QUICK SHUTOFF	0–17	0	Allows the TV to be turned OFF with press and hold of pillow speaker channel buttons. Set to 0 to disable. Set from 1 to 17 to define hold time. See detailed descriptions.
078	UPN MSB	0–255	255	User programmable number, most significant byte.
079	UPN MSB-1	0–255	255	User programmable number, most significant byte - 1.
080	UPN MSB-2	0–255	255	User programmable number, most significant byte - 2.
081	UPN LSB	0–255	255	User programmable number, least significant byte.
082	CHKSUM ERROR	0 / 1	1	Enforces rigid MPI checksum.
083	HANDSHK TIME	0–5	5	Determines the MPI timing requirement of an MPI command to follow an MPI Status Response.
084	PERMANENT BLK	0 / 1	0	Set to 1 to remove the blocking hours setting in the Function Menu for Parental Control and make the block permanent.
088	EN NOISE MUTE	0 / 1	1	(Analog channels only) If set to 1, audio is muted if no signal is present.
090	KEY LOCK	0 / 1	0	If set to 1, the display panel power button function is locked. IR is still functional.
091	HDMI2 ENABLE	0–2	1	Set to 0 to disable HDMI 2. Set to 1 (DTV Mode) or 2 (PC Mode), as applicable, to enable HDMI 2.
094	SAP MENU EN	0 / 1	1	Set to 1 to enable the SAP feature in the Function Menu.
096	DEF. ASP. RATIO	0–4	2	Selects the default aspect ratio. See detailed descriptions.
097	PILLOW SPK OUT*	0–2	0	Set as required in accordance with external audio equipment connected to the PILLOW SPEAKER interface connector on the TV. See detailed descriptions.
098	PRO:CENTRIC	0, 2, 3	0	Set to 0 to disable the Pro:Centric application. Set to 2 for GEM (Java Application) Mode. Set to 3 for HTML Mode.
099	BACK LIGHTING	1–202, 255	255	Sets the level of the TV picture back lighting. See detailed descriptions.
101	IR FEEDBACK	0 / 2	0	Set to 2 to disable the TV's MMR feature.

\* This item is available with PTC v1.00.021 or later, and this feature is only applicable with CPU v4.48.30 or later.

## Installer Menu Items 102 through 122

Item	Function	Value Range	Default Value	Brief Description of Function
102	ATSC BAND	0–4	4	Selects the RF band used by the ATSC tuner. See detailed descriptions.
103	ATSC TUNE MODE	0 / 1	1	Set to 1 for Physical Channel tuning. Set to 0 for Virtual Channel tuning.
104	START MINOR CH	0–255	0	Selects the Minor Start Channel number. Set to 0 for analog (NTSC) channel.
106	ASP RATIO LOCK	0 / 1	0	Set to 0 to use the default aspect ratio each time the TV is turned ON. Set to 1 to retain the aspect ratio set before the TV was turned OFF.
107	BANNER SELECT	0 / 1	1	Selects the type of native Channel-Time banner to display during channel change.
116	VIDEO MUTE EN	0 / 1	0	(Analog channels only) If set to 1, video mutes (blank screen) when no signal is present.
117	FACT DEFAULT	0 / 1	0	Set to 1 to restore the factory default settings of all Installer Menu items.
118	POWER SAVINGS	1, 3, 7	3	Determines the powered status of the embedded b-LAN module and the GAME CONTROL/MPI port. See detailed descriptions.
119	DATA CHANNEL	0–135, 253, 254, 255*	255	Set to 0 to disable. Set from 1 to 135 to match the RF channel number used by the Pro:Centric server as its data channel. Set to 255 to use Auto Search to find the Pro:Centric RF channel. See detailed descriptions.
121	UPDATE TIME HR	0–23, 128, 255	128	Sets the Wake For Update hour. See detailed descriptions.
122	UPDATE TIME MN	0–59, 255	0	Sets the minute for Wake For Update. See detailed descriptions.

\* Value 254 applicable with CPU v4.41.00 or later and PTC v1.00.011 or later.

## Detailed Descriptions of Installer Menu Items

### 000 - INSTALLER SEQUENCE

Specifies entry sequence to the Installer Menu.

0 = 9876                    1 = 4321  
2 = 1478                    3 = 3698

### 001 - POWER MANAGE (Power Management)

As an energy saving feature, this item determines the number of hours, in the range 1 to 7, of inactivity allowed, either at the TV control panel or from the remote, before the TV automatically turns itself OFF.

In addition to Power Management setting, values 8 to 15 determine the availability of the Force TV Reboot with IR Remote feature when Installer Menu item 002 AC ON is set to 1, 3, 17, or 19 (see also item 002 description). While the TV is ON, perform the following steps to force the reboot: 1) Press and hold the POWER key on the Installer Remote for at least five seconds, and then release it. 2) Within two seconds of releasing the POWER key, press the numeric key sequence 3-1-4 (you will have two seconds to press each numeric key). During the reboot process, the TV will initiate an update event (see also item 121 UPDATE TIME HR description). After reboot, the TV returns to its ON state.

See table below for all values. If set to 0 or 8, Power Management is disabled.

**Note:** Values 8 to 15 are applicable with PTC v1.00.029 or later.

Value	Power Mgmt	Force TV Reboot	Value	Power Mgmt	Force TV Reboot
0	Disabled	Disabled	8	Disabled	Enabled
1	1 hour	Disabled	9	1 hour	Enabled
2	2 hours	Disabled	10	2 hours	Enabled
3	3 hours	Disabled	11	3 hours	Enabled
4	4 hours	Disabled	12	4 hours	Enabled
5	5 hours	Disabled	13	5 hours	Enabled
6	6 hours	Disabled	14	6 hours	Enabled
7	7 hours	Disabled	15	7 hours	Enabled

### 002 - AC ON (AC Power Switchable)

Determines the status of the TV when AC power is applied. Set to 0 (default) for standard TV turn ON/OFF operation. Set to 16 if you would like the TV to turn ON the first time AC power is applied, after which the TV will be configured for standard ON/OFF operation.

\* Exception: If the TV is externally rebooted within the previous 24 hours, the subsequent update event will take place at the next designated reboot time, which could be up to 48 hours from the time of the external reboot.



## Installer Menu (Cont.)

If set to 1 or 17 (Always ON), the TV will turn ON when AC power is applied. Pressing the POWER button is not necessary. This is desirable if the TV is plugged into a switched AC outlet (i.e., a set-top box). Though note that if the Pro:Centric application is loaded (i.e., item 098 PRO:CENTRIC is not set to 0), the TV will reboot and initiate an update once every 24 hours.\* During the update event, the TV checks for and downloads any available updates from the Pro:Centric server (item 119 DATA CHANNEL set from 1 to 135, 253, or 254). The time at which this event occurs depends on the setting of item 121 UPDATE TIME HR. See item 119 and 121 descriptions for further information. Once the update cycle is complete, the TV completes the reboot and returns to its ON state.

**Note:** If set to 1 or 17, the TV does not respond to ON/OFF commands from either the remote or the display panel, and the Sleep Timer is also nonfunctional.

Set to 2, 3, 18, or 19 to enable the Instant ON feature, as required. The Instant ON feature allows the TV to turn ON when AC power is applied, but with video and audio muted (Muted ON). The TV remains powered ON while appearing to be OFF. Pressing the POWER button toggles off/on the video and audio mutes, so that the TV appears to turn ON instantly. Set to the appropriate value to enable Instant ON with reboot (value 2 or 18) or Instant ON without reboot (value 3 or 19), respectively. See bullets below for further information on reboot functionality. See also note below.

**Note:** Values 2 and 3 represent standard Instant ON functionality; i.e., when AC power is applied, the TV is in a Muted ON state. If set to 18 or 19, the Instant ON feature allows the TV to turn ON, without muting video and audio, when AC power is initially applied.

- Instant ON with reboot: The TV will reboot and, if applicable (i.e., item 119 DATA CHANNEL set from 1 to 135, 253, or 254), check for and download any available updates from the Pro:Centric server at every turn OFF. This setting is not recommended if the TV will be configured with a resident application.
- Instant ON without reboot: The TV will not reboot to check for and download updates at turn OFF, with the following exception: the first time the TV is turned OFF after this item is set to 3 or 19, the TV will reboot and initiate an update event (Data Channel Auto Search and/or check for and download of updates—see also paragraph below). This setting is recommended if the TV will be configured with a resident application. In this mode, the standard check for and download of updates is under application control. Refer to your site-specific documentation for further information on configuring the TV with a resident application.

When this item is set to 2, 3, 18, or 19, the TV also will reboot and initiate an update event once every 24 hours. During the update event, the TV, as applicable, performs a Data Channel Auto Search (item 119 set to 255) and/or checks for and downloads any available updates from the Pro:Centric server (item 119 set from 1

to 135, 253, or 254). The time at which this event occurs depends on the setting of item 121 UPDATE TIME HR. See item 119 and 121 descriptions for further information. Once the update cycle is complete, the TV completes the reboot and returns to its Muted ON state.

**Note:** Instant ON is not supported when the TV is in MPI-EXT Mode, EBL-LNT Mode, or FTG Mode via EBL.

### 003 - BAND/AFC (Tuning Band)

Selects the RF band used by the NTSC tuner:

0 = Broadcast	1 = Cable (default)
2 = HRC	3 = IRC

Determine the RF band used by the RF distribution system, and then select the appropriate value for this item before tuning channels or running Channel Tuning (Channel Search). See also item 102 ATSC BAND.

### 004 - STRT CHANNEL (Start Channel)

If active, this function allows you to determine the initial Major Start Channel number when the TV is turned ON. This feature is useful for an in-house information channel, since the TV would always select that channel when it is turned ON. If set to 255, the last channel tuned before the TV was turned OFF will be the channel tuned when the TV is turned ON again.

0 = Aux	127 = Map to Major CH 4
1 – 125 = Major Ch. #	253 = IP Start Channel
126 = Map to Major CH 3	255 = Last Channel

For a digital (ATSC) Start Channel, always remember to set item 104 to the Minor Start Channel number. If setting this item to 0 (Aux), make sure to also set item 046 STRT AUX SRCE to the appropriate value.

**Note:** 126 and 127 are mapped only in SONIFI PPV Mode.

**Note:** The IP Start Channel shown above can only be set in the Cloud Configuration Tool, which is typically used to configure TV CPUs for FTG Mode. The same applies for the additional Major Channel number range of 128–135 in Physical tuning and 128–999 in Virtual tuning mode. When the TV is in FTG Mode via CPU, the appropriate values will be visible in the (read-only) Installer Menu. For an IP Start Channel, item 004 will show value 253, the IP address, and the port number. For an RF Start Channel, item 004 will show the channel's Major and Minor numbers.

**Note:** If the TV is being configured for Application Tuning Mode operation with Pro:Centric Direct, the Start Channel is set in the Pro:Centric Direct Admin Client, and Installer Menu item 004 is automatically updated accordingly. When the TV is in Application Tuning Mode, the appropriate values will be visible in the (read-only) Installer Menu. For an IP Start Channel, item 004 will show value 253, the IP address, and the port number. For an RF Start Channel, item 004 will show the channel's Major and Minor numbers.



## 005 - CHAN LOCK (Channel Lock)

Channel Lock is ideal if the system must always be on the same channel. If set to 1, Channel Lock is enabled and it is not possible to change channels. If set to 0 (default), Channel Lock is disabled. Generally, this feature is used in connection with item 004 STRT CHANNEL where the Start Channel may, for example, be set to 3 or 4. If the Start Channel is 3, then the TV will remain locked on channel 3.

### **NOTE:** For items 007, 008, and 009

For legacy reasons, the scale used is 0–63. The PTC software will translate this to the 0–100 scale used by the TV.

To translate a TV volume level to the Installer Menu value, use the following formula:

$$\text{Installer Value} = \frac{\text{TV Value} \times 63}{100}$$

Enter only the whole number (disregard fractions).

## 007 - STRT VOLUME (Start Volume)

This function allows you to determine the initial volume level setting on the TV when it is turned ON. The range of values for this item is 0 to 63, 255. If set to 255, the last TV volume level before the TV was turned OFF will be the current volume level when the TV is turned ON again.

**Note:** The factory default TV volume level (i.e., when AC power is initially applied) for these TV models is 20. In addition, if AC power is removed/disconnected and then reapplied to the TV while this item is set to 255, the TV volume level will revert to 20 when the TV is turned ON again, with the following exceptions: for item 002 AC ON settings 16–19, the TV volume level will remain at the last volume level.

## 008 - MIN VOLUME (Minimum Volume)

This function determines the minimum volume level allowable with the Volume (VOL) Up/Down control. In this way, for example, someone cannot set the volume too low to hear. The value range for this item is from 0 to 63. The factory default is 0, which provides the full range of TV volume control, if item 009 MAX VOLUME is set to 63. It is recommended to set the same value on every TV.

**Note:** The minimum volume level cannot have a value setting higher than the maximum volume level (described below).

## 009 - MAX VOLUME (Maximum Volume)

This function determines the maximum volume level allowable with the Volume (VOL) Up/Down control. In this way, for example, someone cannot set the volume level high enough to disturb others. The value range for this item is 0 to 63, with 63 as the default, which provides the full range of TV volume control, if item 008 MIN VOLUME is set to 0. It is recommended to set the same value on every TV.

**Note:** The maximum volume level cannot have a value setting lower than the minimum volume level (described above).

## 010 - MUTE DISABLE

Enables or disables the sound Mute function. If set to 0 or 2, sound can be muted. If set to 1 or 3, sound cannot be muted. If set to 2, when the TV volume is either 0 or muted, the Volume Mute icon will remain visible on the screen. If set to 3, when the TV volume is 0, the Volume Mute icon will remain visible on the screen.

**Note:** Values 2 and 3 are applicable with CPU v4.43.50 or later and PTC v1.00.014 or later.

## 012 - IR BANKS EN. (IR Banks Enable)

When enabled, you can direct access a particular channel bank by inputting the discrete IR code for that bank.

**Note:** This item is not available in the Installer Menu when item 027 HOSPITAL MODE is set to 0.

## 013 - SCAN MODE

If set to 1, the TV can be turned ON with Channel Up/Down key presses. Also, the TV will turn OFF when Channel Up/Down is used to tune above or below the Channel Map pivot point. By default, the Channel Map pivot point is between the highest and lowest channel in the Channel Map (also see item 014 STRT CH IN SM). Set to 0 (default) to disable.

**Note:** This item is only applicable when the TV is in PTC-CTV Mode or FTG Mode via CPU.

## 014 - STRT CH IN SM (Start Channel in Scan Mode)

Only valid when item 013 SCAN MODE is set to 1 (enabled). Set to 1 to force the Channel Map pivot point to be between the RF channel designated as the Start Channel (see item 004 STRT CHANNEL) and next lower channel in the Channel Map. Set to 0 (default) to disable.

**Note:** This item is not available in the Installer Menu when item 013 SCAN MODE is set to 0.

## 015 - SLEEP TIMER

If set to 1, the Sleep Timer feature is enabled and available to the end user. Set to 0 to disable the Sleep Timer feature.

## 016 - EN TIMER (Enable On/Off Timers)

If set to 1, the Timer function is enabled and available to the end user. Set to 0 to disable On/Off timers.

**Note:** The TV clock must be set in order for timers to be used.

## 017 - ALARM

If set to 1, the Alarm feature is enabled and available to the end user in the Function Menu (i.e., the TV is not in Pass-through Mode). Set to 0 to disable the Alarm feature.

**Note:** The TV clock must be set before the Alarm feature will work.

# Installer Menu (Cont.)

## 020 - FEATURE LEVEL

Determines an additional IR code scheme to which the TV will respond, allowing for the use of unique IR codes based on “bed number” in a multi-TV single room installation. First determine the IR mode; then select the bed number.

**Note:** When item 027 HOSPITAL MODE is set to 0 and pillow speaker configuration is still required, the IR scheme that will control the TV and the speaker selection are determined by this item (default = 1). For a “Zenith” pillow speaker, select only Bed #2, along with the desired Speaker value. For a Pro:Centric pillow speaker, select the desired Speaker value.

Value	IR Mode	Bed #	Speaker
0–1	Zenith*	1–2	TV Only
2	IMX**	N/A	TV Only
3	Zenith 6-bit**	N/A	TV Only
16–31	Multi-code Remote	1–16	TV Only
64–65	Zenith*	1–2	Pillow Only
66	IMX**	N/A	Pillow Only
67	Zenith 6-bit**	N/A	Pillow Only

\* Decoded internally or supported with custom remote registration.

\*\* Only supported with custom remote registration.

**Note:** Values 25 to 31 are applicable with PTC v1.00.011 or later. Values 2 and 66 are applicable with PTC v1.00.013 or later. Values 3 and 67 are applicable with PTC v1.00.025 or later.

**Note:** See Reference section, “LG Pro:Centric Patient Remote and Pillow Speaker,” for additional details. Also, see documentation for the accessory package that includes the multi-code remote.

## 021 - V-CHIP (Parental Control)

Set to 1 to activate V-Chip (Parental Control) and have it available to the end user to filter and control or otherwise restrict programming content that can appear. Set to 0 to turn off the V-Chip feature (not available to end user); no programming restrictions can be set.

## 022 - MAX BLK HRS (Maximum Block Hours)

Sets hours from 0 to 99 for the maximum number of Parental Control blocking hours that can be set in the Function Menu (i.e., the TV is not in Pass-through Mode). Default setting is for 12 blocking hours.

**Note:** This item is not available in the Installer Menu when item 021 V-CHIP is set to 0 or when item 084 PERMANENT BLK is set to 1.

## 023 - POWER ON CC

If set to 0, closed captions are off when the TV is turned ON. If set to 1, the closed caption setting selected before the TV was turned OFF will be the current caption setting when the TV is turned ON again.

Set to 2 (Start) to specify closed caption settings, for both analog and digital channels, when the TV is turned ON. When this item is set to 2, a submenu is displayed in the Installer Menu, and you can select the desired closed caption start setting for analog and digital channels, as indicated in the table below.

023 POWER ON CC	002 Start
ANALOG CC	3 CC1
DIGITAL CC	0 Off

Value	Analog Channel CC	Value	Digital Channel CC
0	CC1 (default)	0	Off (default)
1	CC2	1	Service 1
2	CC3	2	Service 2
3	CC4	3	Service 3
4	Text1	4	Service 4
5	Text2	5	Service 5
6	Text3	6	Service 6
7	Text4		

**Note:** When “Off” is selected as the digital channel closed caption setting, the closed captions for digital channels will be the same as the setting for analog channel closed captions.

To access the submenu, with item 023 on display in the Installer Menu, press **MENU** on the Installer Remote (without pressing a numeric key before it). Once in submenu, use the Up/Down arrow keys on the Installer Remote to navigate between the ANALOG CC and DIGITAL CC fields, and use the Left/Right arrow keys to select the appropriate value in each field. To exit the submenu and return to the main menu item 023, press **MENU** again.

**Note:** Value 2 is applicable with PTC v1.00.014 or later. The submenu shown above is only displayed when value 2 is selected.

## 025 - FUNCTION PRE (Function Preview)

Set to 1 to allow access to the Channel Preview/Banks Setup Menu via the CH PREVIEW key (available only on legacy Zenith IR remotes). Set to 0 to disable access to the Channel Preview/Banks Setup Menu.

**Note:** This item is only applicable when the TV is in PTC-CTV Mode.

## 027 - HOSPITAL MODE

Set accordingly, for the desired speaker selection, the pillow speaker IR scheme/supply voltage, and/or the hospital remote IR scheme. To control the TV with a “Zenith” pillow speaker, select only Zenith (+12v) pillow speaker voltage and Zenith Bed #2 remote IR scheme (e.g., set to 2 or 130) in accordance with the desired Speaker value. For a Pro:Centric pillow speaker, select any Zenith (+12v) pillow speaker voltage in accordance with the desired Speaker value. See table below.

When Hospital Mode is set to 0 (disabled), both the IR scheme that will control the TV and the speaker selection depend on the Installer Menu item 020 FEATURE LEVEL setting.

Value	Speaker	Pillow Speaker IR Scheme/Voltage	Hospital Remote IR Scheme
000	Determined by item 020 setting	Zenith (+12v)	Determined by item 020 setting
001	Pillow Only	Zenith (+12v)	Zenith Bed #1
002	Pillow Only	Zenith (+12v)	Zenith Bed #2
017	Pillow Only	Philips (+5v)	Zenith Bed #1
018	Pillow Only	Philips (+5v)	Zenith Bed #2
033	Pillow Only	RCA (-5v)	Zenith Bed #1
034	Pillow Only	RCA (-5v)	Zenith Bed #2
065	TV Only	Zenith (+12v)	Zenith Bed #1
066	TV Only	Zenith (+12v)	Zenith Bed #2
081	TV Only	Philips (+5v)	Zenith Bed #1
082	TV Only	Philips (+5v)	Zenith Bed #2
097	TV Only	RCA (-5v)	Zenith Bed #1
098	TV Only	RCA (-5v)	Zenith Bed #2
129	Both Pillow & TV	Zenith (+12v)	Zenith Bed #1
130	Both Pillow & TV	Zenith (+12v)	Zenith Bed #2
145	Both Pillow & TV	Philips (+5v)	Zenith Bed #1
146	Both Pillow & TV	Philips (+5v)	Zenith Bed #2
161	Both Pillow & TV	RCA (-5v)	Zenith Bed #1
162	Both Pillow & TV	RCA (-5v)	Zenith Bed #2
254	TV Only	Disabled (0v)	Zenith Bed #2

**Note:** When this item is set to 254 (factory default value), there is no power (voltage) supplied to the pillow speaker interface. “254” is not selectable in the Installer Menu. If you ever need to restore the default setting, you must reload the factory default settings. See item 117 description and/or Reference section, “Restoring Factory Defaults on the TV(s),” for further information.

**Note:** When Hospital Mode is enabled, i.e., not set to 0, channel banks are automatically applied, which means that the (Lodging) TV Zoning feature is not available. To disable channel banks and enable the TV Zoning feature, Hospital Mode must be disabled, i.e., set to 0. In this case, set Installer Menu item 020 FEATURE LEVEL as required to select the appropriate IR code scheme. See also “Channel Banks Overview” on pages 40 to 42 and/or Reference section, “Using the TV’s Zoning Features,” for further information.

**Note:** In the Installer Menu, an informational code is displayed at the right of each Hospital Mode value. Each code consists of three characters. The first character—T, P, or B—identifies the speaker: TV, Pillow, or Both. The second character—Z, P, R, or D—identifies the pillow speaker IR scheme: Zenith, Philips, RCA, or Disabled. The third character—1 or 2—identifies the Zenith IR remote bed number. In the table above, each bolded character represents an element of the Hospital Mode code.

## 028 - CH. OVERRIDE (Channel Override)

This item either allows or restricts tuning of channels that are NOT in the PTC Channel Map. If set to 1, end users can tune channels that are not in the PTC Channel Map by direct keypad entry. If set to 0, end users are restricted to only the channels that are in the PTC Channel Map. In the case of CPU-CTV Mode, there are no channels in the PTC Channel Map; therefore, direct keypad entry is not available. Also, when this item is set to 0, the PTC Channel Map (PTC-CTV Mode)/CPU channel lineup (CPU-CTV Mode) is locked, and end user access to channel settings in the TV setup menus is restricted.

**Note:** This item is not applicable when the TV is in FTG Mode or Application Tuning Mode.

## 029 - REMAP AUX INPS

Set to 1 to remap the PTC’s direct tune channels for Aux inputs from 13x to 9x. This allows 2-digit only tuning systems (i.e., legacy On Command Video™) to direct tune Aux inputs. See also Reference section, “TV Aux Input Configuration.”

**Note:** This item is not applicable when the TV is in FTG Mode or Application Tuning Mode.

## 030 - EXTCTL/ACKMASK

Determines status of MPI ACK Mask feature, as well as availability of external control either via MPI (using MPI port) or via TLT (using RS-232C Control port). See table below.

Value	External Control Port				ACK Mask Feature
	CPU-CTV Mode		CPU-FTG / CPU-P:C Mode		
	MPI	RS-232C Control	MPI	RS-232C Control	
0	O	O	X	X	Disabled
1	O	O	X	X	Enabled
2	O	X	O	X	Disabled
3	O	X	O	X	Enabled
4	X	O	X	O	Disabled
5	X	O	X	O	Enabled

O = Available X = Prohibited

**Note:** Values 2 to 5 (Ext Ctrl) are applicable with CPU v4.46.60 or later and PTC v1.00.020 or later.

## 031 - POLL RATE

MPI Communication Parameter. Selects the poll rate for MPI. Step size of 16 ms. Changing from default may affect communication via MPI.

## 032 - TIMING PULSE

MPI Communication Parameter. Sets the baud rate for MPI. Step size of 4.3 uS. Changing from default may affect communication via MPI.

# Installer Menu (Cont.)

## 035 - HDMI1 ENABLE

Set to 1 to enable HDMI 1 input in DTV Mode. Set to 2 to enable HDMI 1 input in PC Mode. Set to 0 to disable display panel HDMI 1 input.

## 041 - SIMPLINK EN

Set to 0 to disable the SIMPLINK feature. Set to 1 to enable SIMPLINK functionality (does not enable remote control access to the SIMPLINK Menu).

**Note:** When both this item *and* item 042 AUTO INPUTS are enabled in the Installer Menu, HDMI inputs will be detected by SIMPLINK, but the Auto Input(s) Sensing Feature will not function.

**Note:** ARC functionality requires that SIMPLINK be enabled.

## 042 - AUTO INPUTS

Determines the Aux inputs for which auto-sensing is enabled. Set to 0 to disable auto-sensing for all available inputs. Set to 255 to enable auto-sensing for all available inputs. For information on options for individual input settings, see Reference section, "Auto Input(s) Sensing Feature."

**Note:** In order for auto-sensing to be enabled for an input, that input must also be enabled in the Installer Menu. For example, to enable auto-sensing for HDMI 1, item 035 HDMI1 ENABLE must also be set to 1 or 2. Also, see note above regarding TV operation when both this item and item 041 SIMPLINK EN are enabled.

## 046 - STRT AUX SRCE (Start Aux Source)

Sets the starting Aux source. When turned ON, the TV will tune to the starting Aux source if item 004 STRT CHANNEL is set to 0.

3 = HDMI 1      5 = HDMI 2      255 = Last Aux

**Note:** In order for an Aux input to be selected as the starting Aux source, the input also must be enabled in the Installer Menu.

**Note:** This item is not available in the Installer Menu unless item 004 STRT CHANNEL is set to 0.

## 047 - AUX STATUS

Controls the MPI status channel response for Aux sources. Set to 1 for the Aux source to be reported as its channel number. Set to 0 for the Aux source to be reported as channel 0. See Reference section, "TV Aux Input Configuration," for Direct Access channel numbers.

## 049 - DIS. AUDIO M. (Disable Audio Menu)

Determines the availability of the Sound Out (Audio) Menu in the TV menus. Also determines the default Audio Mode when TV is turned ON. See the table below and set as required. See also notes below, in particular, that regarding items 020 and 027.

Value	Sound Out Menu Status	Default Audio Mode at TV Turn ON
0 (default)	Enabled	TV Speaker
1	Disabled	TV Speaker
2	Enabled	External Speaker (Optical)
3	Disabled	External Speaker (Optical)
4	Enabled	LG Sound Sync (Optical)
5	Disabled	LG Sound Sync (Optical)
6	Enabled	LG Sound Sync (Wireless/BT)
7	Disabled	LG Sound Sync (Wireless/BT)
8	Enabled	TV Speaker + Audio Out (Optical)
9	Disabled	TV Speaker + Audio Out (Optical)
10	Enabled	External Speaker (HDMI ARC)
11	Disabled	External Speaker (HDMI ARC)
16	Enabled	TV Speaker + BT Surround Sound
17	Disabled	TV Speaker + BT Surround Sound

**Note:** Values 10 and 11 are only available if item 041 SIMPLINK EN is set to 1 (enabled).

**Note:** If a SIMPLINK-enabled device is connected to the TV and item 041 SIMPLINK EN is set to 1 (enabled), the SIMPLINK device Audio Mode will have priority over the setting of this item when the TV is turned ON.

**Note:** Items 020 FEATURE LEVEL and 027 HOSPITAL MODE have priority over the setting of this item. Thus, if either item 020 or 027 is set to a Pillow Only value and this item is set to an internal TV speaker value, the pillow speaker setting will have priority, and you will not be able to hear sound from the TV speaker. You may however, set an external speaker configuration in conjunction with the pillow speaker, so that you can hear sound from external speaker equipment when connected.

## 053 - DIS. CH-TIME (Disable Channel-Time Banner)

Set to 1 to disable display of the TV's native Channel-Time banner when a custom channel label/channel information will be provided by the MPI command. Set to 0 to enable display of the TV's native Channel-Time banner.

**Note:** This item is not applicable when the TV is in FTG Mode or Application Tuning Mode.

## 069 - EN. CH-T COL. (Enable Display Characters Custom Color)

Set to 1 to enable custom color for MPI display characters. Set to 0 to disable custom color for MPI display characters.

## 070 - FOR. CH-TIME (Display Characters Foreground Color)

Set the foreground color for MPI display characters according to the following color chart:



0 = Black      2 = Green      4 = Red      6 = Yellow  
1 = Blue      3 = Cyan      5 = Violet      7 = White

If the foreground and background colors for the display characters are the same, the background will be transparent.

**Note:** This item and item 071 BCK. CH-TIME also apply to the "Channel Not Available" message if item 073 CH NOT AVBLE is set to 1 (enabled).

**Note:** Items 070 FOR. CH-TIME and 071 BCK. CH-TIME are only available in the Installer Menu when item 069 EN. CH-T COL. is set to 1.

### 071 - BCK. CH-TIME (Display Characters Background Color)

See description for item 070 FOR. CH-TIME above. The color chart is the same for both items.

### 073 - CH NOT AVBLE (Channel Not Available)

If set to 1 and item 028 CH. OVERRIDE is set to 0, a "CHANNEL NOT AVAILABLE" message is displayed when the end user attempts to direct tune a channel that is not included in the channel lineup.

**Note:** This item is not available in the Installer Menu when item 028 CH. OVERRIDE is set to 1.

**Note:** This item is only applicable when the TV is in PTC-CTV Mode.

### 075 - REVERT CH (Revert to Start Channel)

If set to 1 and loss of MPI communication occurs, the TV automatically tunes to the specified Start Channel.

**Note:** This item is not available in the Installer Menu when item 004 STRT CHANNEL is set to 255. This item also is not available in the Installer Menu when item 004 STRT CHANNEL is set to 0 and 046 STRT AUX SRCE is set to 255.

### 077 - QUICK SHUTOFF

Allows the end user to turn OFF the TV using the mechanical (analog) pillow speaker Channel Up/Down keys. The user needs to press and hold either channel key for the time determined by the value set. Set to 0 to disable. Set from 1 to 17 to establish the required hold time of the key—from 2 seconds to 10 seconds in half-second increments.

**Note:** This item is not available in the Installer Menu when item 013 SCAN MODE is set to 0.

### 078 - UPN MSB (UPN Most Significant Byte)

User programmable number, most significant byte readable by MPI command. Note: Not linked to serial number.

### 079 - UPN MSB-1 (UPN Most Significant Byte-1)

User programmable number, most significant byte-1 readable by MPI command. Note: Not linked to serial number.

### 080 - UPN MSB-2 (UPN Most Significant Byte-2)

User programmable number, most significant byte-2 readable by MPI command. Note: Not linked to serial number.

### 081 - UPN LSB (UPN Least Significant Byte)

User programmable number, least significant byte readable by MPI command. Note: Not linked to serial number.

### 082 - CHKSUM ERROR (Checksum Error)

Enforces rigid MPI checksum validation. Set to 1 for validation. Set to 0 to disable (does not check checksum on MPI async port). SPI is always checked.

### 083 - HANDSHK TIME (Handshake Time)

Determines the MPI timing requirement of the (STB's) MPI command to follow the end of the transmission of the (display's) MPI Status Response. Value range is 0 to 5. Changing from default may affect communication via MPI. (Handshake Time = 25.5 ms + [25.5 ms x item value])

### 084 - PERMANENT BLK (Permanent Block)

Allows Parental Control blocking schemes to be permanent by disabling the end user's ability to limit blocking hours in the Function Menu. Set to 1 to install Parental Control restrictions permanently. Set to 0 for end user-specified hours control of blocking schemes. See also item 022 MAX BLK HRS.

**Note:** This item is not available in the Installer Menu when item 021 V-CHIP is set to 0.

### 088 - EN NOISE MUTE (Enable Noise Mute)

Applicable for analog channels only. If set to 1, audio mutes if no signal is present.

### 090 - KEY LOCK

If set to 1, Key Lock is enabled, which means that the display panel power button function will be locked, i.e., non-functional. Set to 0 to disable Key Lock. Note that all IR features remain functional regardless of this setting.

### 091 - HDMI2 ENABLE

Set to 1 to enable HDMI 2 input in DTV Mode. Set to 2 to enable HDMI 2 input in PC Mode. Set to 0 to disable display panel HDMI 2 input.

### 094 - SAP MENU EN (2nd Audio Program)

Set to 1 to enable the SAP feature in the Function Menu (i.e., the TV is not in Pass-through Mode). Set to 0 to disable the SAP feature in the Function Menu.

### 096 - DEF. ASP. RATIO (Default Aspect Ratio)

Selects the aspect ratio to be set as default each time the TV is turned ON:

0 = Set By Program      1 = 4:3  
2 = 16:9 (default)      3 = Just Scan  
4 = Zoom

**Note:** See also item 106 ASP RATIO LOCK. This item (i.e., item 096) is not available in the Installer Menu when item 106 is set to 1.

# Installer Menu (Cont.)

## 097 - PILLOW SPK OUT

Determines the maximum output wattage of the mono analog audio signal to the PILLOW SPEAKER interface connector on the TV. See the table below and set as required in accordance with external audio equipment connected to the TV's PILLOW SPEAKER interface connector. See also Reference section, "Pillow Speaker Setup" for interface details.

	Value	Maximum Wattage
PILLOW SPEAKER Interface Output	0 (default)	1 Watt
	1	0.2 Watts
	2	0.07 Watts

**Note:** This item is available with PTC v1.00.021 or later, and this feature is only applicable with CPU v4.48.30 or later.

## 098 - PRO:CENTRIC

Selects the Pro:Centric Application Mode. Set to 0 (default) to disable the Pro:Centric application. Set to 2 for GEM (Java Application) Mode. Set to 3 for HTML Mode.

Once you exit the Installer Menu, turn OFF the TV for at least one minute to initiate the Pro:Centric application download. When you turn the TV back ON, wait several minutes to allow the TV to load the Pro:Centric application after the initial download. Then, press the PORTAL key on the Installer Remote, and verify that the Pro:Centric application appears on the display.

**Note:** This item is not available in the Installer Menu when item 119 DATA CHANNEL is set to 0.

## 099 - BACK LIGHTING

Sets the TV screen brightness. Default setting is 255.

- 1 (dimmiest picture)– 100 (brightest picture) Static Back Lighting
- 101 (dimmiest picture)– 200 (brightest picture) Dynamic Back Lighting: The TV automatically controls back lighting depending upon the picture level of the current program.
- 201 Automatic Static Back Lighting: The TV automatically controls back lighting by using Intelligent Sensor to detect the level of ambient lighting.
- 202 Automatic Dynamic Back Lighting: The TV automatically controls back lighting by using Intelligent Sensor to detect the level of ambient lighting and depending upon the picture level of the current program.

If set to 201 or 202, back lighting can be controlled via the Picture settings in the TV setup menus. However, each time the TV is turned ON, Picture Mode (set in Picture Menu) is defaulted to Intelligent Sensor. If Picture Mode is manually set to a static option (Vivid, Standard, etc.) during a viewing session, Intelligent Sensor is temporarily disabled.

If set to 255, back lighting is controlled via the Picture settings in the TV's setup menus.

## 101 - IR FEEDBACK

If set to 0 (default), the TV's MMR (Magic Motion Remote) feature is enabled, and a compatible LG MMR (not supplied) may be used with the TV. If set to 2, the MMR feature is disabled.

## 102 - ATSC BAND

Selects the RF band used by the ATSC tuner.

0 = Broadcast      1 = Cable      2 = HRC  
3 = IRC              4 = Same as NTSC (default)

## 103 - ATSC TUNE MODE

Sets the ATSC tuning mode. Set to 1 (default) for Physical Channel tuning. Set to 0 for Virtual Channel tuning.

**Note:** This item must be set to 1 (Physical Channel tuning) to support Pro:Centric RF data channel operation. See also item 119 DATA CHANNEL.

## 104 - START MINOR CHANNEL

When a digital (ATSC) Start Channel has been specified for item 004 STRT CHANNEL, this item sets the Minor Start Channel number. Set to 0 when an analog (NTSC) Start Channel has been specified for item 004.

**Note:** This item is not available in the Installer Menu when item 004 STRT CHANNEL is set to 0 or 255.

## 106 - ASP RATIO LOCK (Aspect Ratio Lock)

Set to 0 to use the default aspect ratio each time the TV is turned ON (see item 096 DEF. ASP. RATIO). If set to 1, the aspect ratio set before the TV was turned OFF will be the current aspect ratio when the TV is turned ON again.

## 107 - BANNER SELECT

Selects the type of native Channel-Time banner to display during channel change. Set to 1 for channel label display, plus channel information (full banner). Set to 0 for channel label display only (small banner). See also item 053 DIS. CH-TIME.

## 116 - VIDEO MUTE EN (Video Mute Enable)

Applicable for analog channels only. If set to 1, video mutes (blank screen) when no signal is present.

## 117 - FACT DEFAULT (Factory Default)

Set to 1 and press OK to restore the factory default settings of all Installer Menu items. Once complete, the value returns to 0.



**Caution: If set to 1, this clears all Installer Menu custom settings and restores the factory default settings. It also clears the channel lineup, including any assigned channel icons and custom text labels.**

**Note:** See also Reference section, "Restoring Factory Defaults on the TV(s)," for further information.

## 118 - POWER SAVINGS

Default set to 3—the power circuitry for both the embedded *b*-LAN module and the GAME CONTROL/MPI port is only powered when the TV is turned ON. When the TV is turned OFF, the embedded *b*-LAN and the GAME CONTROL/MPI port are not powered.

Note that the TV must be turned ON in order to communicate with the embedded *b*-LAN module for configuration and control when POWER SAVINGS is set to 3. If POWER SAVINGS is set to 1, the *b*-LAN module is always powered.

Similarly, if MPI communication is required for external MPI control, POWER SAVINGS should be set to 1 so that the GAME CONTROL/MPI port circuitry is always powered.

**Note:** See Reference section, “*b*-LAN Setup & Overview,” for further information.



**Caution: POWER SAVINGS should NEVER be set to 7. This setting is intended for factory use only.**

## 119 - DATA CHANNEL

Set to 0 to disable. Set from 1 to 135 to match the (physical) RF channel number that will be used by the Pro:Centric server as its data channel.\*

For TVs in Pass-through Mode or FTG Mode via CPU, if left at or set to (default value) 255, the TV's Data Channel Auto Search feature will be enabled. See additional information below.

**Note:** The Data Channel Auto Search feature is not available when the TV's EBL is in FTG Mode. If the DATA CHANNEL value is 255 when the TV is configured for FTG Mode via EBL, DATA CHANNEL is defaulted to 0.

### *Data Channel Auto Search*

When this item is set to 255 (default), once every 24 hours, the TV attempts to find an active Pro:Centric server.

- If connected to an IP network, the TV will first check for a “procentric.local” DNS entry. If the Pro:Centric server IP address is obtained from a DNS server, the DATA CHANNEL value will be changed from 255 to 253, which designates an IP data channel.

**Note:** The automated IP configuration feature requires a “procentric.local” DNS entry, which enables the Auto Search to obtain the Pro:Centric server's IP address. This feature also expects the Pro:Centric server's port number to be set to “80.”

- If an IP data channel is not found, the TV searches for an RF data channel. The TV will initiate a search of 10 predefined RF channels (10, 20, 30, ... 100) and then, if necessary, perform a complete search of the RF channels (1 to 135). If the Pro:Centric RF channel is found, the DATA CHANNEL value will be changed from 255 to match the server's RF channel number.

The time at which the Auto Search occurs depends on the setting of item 121 UPDATE TIME HR (see item 121 description).

**Note:** Pro:Centric updates are downloaded from the Pro:Centric server to the TV when the TV is turned OFF. While Pro:Centric updates are in progress, it is not possible to turn ON the TV.

**Note:** The Data Channel value also is automatically set to 253 if Media Type is set to “IP” either in the Advanced Settings / EZ-Manager Wizard or Hospital Setup Wizard (see “First Use Wizard” on pages 19 to 21) or in the IP Environment / Pro:Centric Menu (see “Pro:Centric Setup” on pages 98 to 102) on the TV or if Installer Menu item #119 Data Channel is set to “IP Address” or “IP Domain Name” in the Cloud Configuration Tool, which is typically used to configure TV CPUs for FTG Mode operation. It is not possible to change the value to “253” directly in the Installer Menu.

**Note:** The Data Channel value is automatically set to 254 if Server Type is set to “Pro:Centric Cloud” either in the Advanced Settings / EZ-Manager Wizard or Hospital Setup Wizard (see “First Use Wizard” on pages 19 to 21) or in the IP Environment / Pro:Centric Menu (see “Pro:Centric Setup” on pages 98 to 102) on the TV or if Installer Menu item #119 Data Channel is set to “P:C Cloud” in the Cloud Configuration Tool. It is not possible to change the value to “254” directly in the Installer Menu.

## 121 - UPDATE TIME HR

Based on the settings of this item and item 122 UPDATE TIME MN, the Wake For Update feature wakes the TV once daily to check for and, if applicable, download updates from the Pro:Centric server.

Set the Wake For Update hour from 0 to 23. This item uses the 24-hour clock format. The default value (128) is displayed as “DFT,” which means Default Time. Directly entering “128” resets the default value (Default Time) for this item. See additional information below.

Under standard TV OFF/ON operating conditions (i.e., item 002 AC ON is set to 0), a Wake For Update event occurs when the TV is OFF and causes the TV's CPU to temporarily turn ON, perform the update cycle, and then turn back OFF, all while the TV appears to be OFF. If item 002 AC ON is set to 2, 3, 18, or 19 for Instant ON, then the TV's CPU is always ON and Wake For Update occurs when the TV is in its Muted ON state (i.e., the TV only appears to be OFF). The Wake For Update event causes the TV's CPU to reboot in order to perform the update cycle and then return to its Muted ON state. See also description for item 002.

Random Distribution of Update Time: If this item is set to 128 (Default Time), the time at which a Data Channel Auto Search (item 119 set to 255) and/or an Instant ON update (item 002 set to 2, 3, 18, or 19) occurs is determined as follows: Each TV initiates the search and/or checks for updates during the 2 AM hour (if the TV clock is set) or after two hours of elapsed time from when AC power was applied (if the TV clock is not set). Also, in this case, a fixed update time minute from 0 to 59 that has been assigned to each TV is used. (The intention of this feature is to prevent all of the installed TVs from performing updates at the same time;

\* PCS150R and later Pro:Centric servers do not support HRC or IRC cable channel frequencies.



## Installer Menu (Cont.)

---

however, note that in installations that have a large quantity of TVs with this feature, there will be some TVs that have the same update minute assignments.) The update time for the TV is displayed at the right of this item in the Installer Menu, for example:

**121 UPDATE TIME HR DFT [02:34]**

If the TV display is ON when a Wake For Update event is to occur, the update will take place the next time the TV is turned OFF.



**Caution: UPDATE TIME HR should NEVER be set to 255 (PREVENT). This setting is intended for factory use only.**

**Note:** Brackets are only shown around the DFT (Default Time) setting. Any other time value for this item will not be shown with brackets.

**Note:** This item is not available in the Installer Menu when item 119 DATA CHANNEL is set to 0, except when item 002 AC ON is set to 2, 3, 18, or 19 for Instant ON. In addition, this item is not available in the Installer Menu when item 002 AC ON is set to 1, unless item 098 is not set to 0.

**Note:** The TV clock must be set in order for a Wake For Update event to occur at the precise time of day in accordance with item 121 and item 122 settings.

### 122 - UPDATE TIME MN

Set the Wake For Update minute from 0 to 59. If item 121 is NOT set to 128 and you wish to invoke the “random” minute assignment on the TV, set this item to 255. See also description for item 121 UPDATE TIME HR above.

**Note:** This item is not available in the Installer Menu unless item 121 UPDATE TIME HR is set from 0 to 23.

**Note:** The TV clock must be set in order for a Wake For Update event to occur at the precise time of day in accordance with item 121 and item 122 settings.

This section describes how to create a customized Master TV Setup for cloning purposes when the TV is in Pass-through Mode. All cloning (export and import) processes on the TV are performed via USB memory device / “.tlx” file. The Master TV Setup may be exported to a Clone (.tlx) file, which can then be used (i.e., imported) to configure either TVs that are to remain in Pass-through Mode or TVs that are to be configured for FTG Mode via CPU.

Cloning requirements and procedures are described in detail on pages 79 to 85.

**Note:** You can also use the Cloud Configuration Tool to create an FTG Configuration (.tlx) file for FTG Mode via CPU configuration/cloning purposes, if desired (see pages 86 to 88). However, it is not possible to customize TV setup menu settings in the Cloud Configuration Tool. If you wish to include customized TV setup menu settings in the TV configuration, in addition to the channel lineup and Installer Menu settings, perform the Master TV Setup procedure to create a Clone (.tlx) configuration file.

## Before You Begin

- It is recommended that you disconnect all Aux inputs if you intend to run Channel Tuning (Channel Search). Under certain conditions, Channel Tuning is disabled if there is an Aux input active.
- A Clone (.tlx) file comprises Installer Menu settings, IP Environment Menu settings (with the exception of unique TV attributes and settings), and all TV sources’ (analog, digital, AV, HDMI, etc.) clonable setup menu settings. See also “Clonable TV Setup Menu Features” list below.
- If the “.tlx” file (either a Clone or FTG Configuration file) to be imported on the Target TV(s) contains an FTG Channel Map, the Target TV(s) will be configured for FTG Mode via CPU, though as part of the import process, depending on the types of channels included in the Channel Map, you may have the option to select either logical or physical channel tuning. If you would like the Target TV(s) to remain in Pass-through Mode, the “.tlx” file should not include an FTG Channel Map.

## Clonable TV Setup Menu Features

Picture	General	Accessibility
Picture Mode Settings	Language	Audio Guidance
	Time	TV Power Sound
<b>Sound</b>	– Clock Mode (Auto/Manual)	High Contrast
Sound Mode Settings	– Time Zone	Closed Caption
Additional Settings	Additional Settings	– Analog Mode
– Volume Mode	– Pointer Options	– Digital Mode
– AV Sync Adjustment	– Menu Transparency	
<b>Channels</b>	– Power Saving Mode (No Signal Power Off)	
Channel Tuning	– Standby Light	
Channel Manager		
Channel Label		

**Note:** Some menu options vary between analog and digital channels and Aux inputs.

**Note:** The Quick Settings Menu is initially displayed when you press **MENU** on the Installer Remote. Select the **All Settings**  menu icon to access the advanced TV setup menus. Several advanced settings are duplicated in the Quick Settings Menu.

# Custom Master TV Setup (Cont.)

## Custom Master TV Setup Procedure

### 1. Turn ON the TV.

The next step depends on whether the First Use Wizard appears on the screen when you turn ON the TV:

- If the wizard is displayed, the TV is in the required factory default state. To continue with this procedure, exit the wizard, and then go to step 2.

**Note:** If desired, you may also use the First Use Wizard / Hospital Setup Wizard to create a Hospital TV Setup for cloning purposes. See “Hospital Setup Wizard” on pages 27 to 42 for further information. Note that TV setup menu customization via the Hospital Setup Wizard is limited to Channel Menu options.

- If the wizard is not displayed, restore the TV to a factory default condition before continuing with this procedure. See Reference section, “Restoring Factory Defaults on the TV(s),” as necessary, for further information.

### 2. Set Installer Menu items.

This step provides specific instruction only on the Installer Menu items that should be set on a Master TV. Refer to pages 61 to 74 for detailed information on all Installer Menu items.

- Use the Installer Remote to access the Installer Menu (see “Accessing the Installer Menu” on page 61 for further information).
- Set Installer Menu item **003 BAND/AFC**, as appropriate.
  - Broadcast: Set to 0.
  - Cable: Set to 1 (default).
  - HRC: Set to 2.
  - IRC: Set to 3.
- Set Installer Menu item **027 HOSPITAL MODE**, as appropriate, to select the speaker configuration.

**Note:** This setting also determines whether channel banks are applied. See item 027 description for further information. The TV Zoning feature is only available when item 027 is set to 0 (i.e., Hospital Mode is disabled).
- Set any other Installer Menu items as necessary, per installation/property requirements. For example, enable/disable Aux inputs, set a Start Channel, etc.
- After you have adjusted all Installer Menu item settings as required, and if you do not need to configure any IP Environment settings (see note below), press **OK** once on the Installer Remote to save your changes; then, press **OK** again to exit the menu.

**Note:** If you intend to configure settings in the IP Environment Menu, which is accessible from the Installer Menu, you can proceed directly to step 3. All Installer Menu settings will be saved automatically when you access the IP Environment Menu.

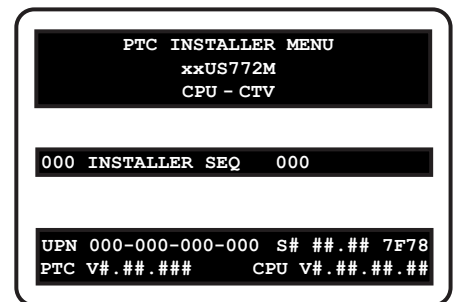

Typical Installer Menu

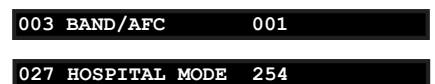

Adjust the values for these Installer Menu items, as required.

(Continued on next page)

(Continued from previous page)

### 3. Configure IP Environment settings.

**Note:** You cannot return directly to the Installer Menu from the IP Environment Menu; thus, you may wish to set all Installer Menu items as needed before you access the IP Environment Menu. Otherwise, you will need to reaccess the Installer Menu to set additional items.

Navigate to Installer Menu item 119 DATA CHANNEL, and press **2-5-3 + MENU** to launch the IP Environment Menu. Then, complete network configuration as required. In particular, if you intend to use the Wi-Fi Zoning feature, you must configure the wireless network connection as part of the Master TV Setup. See “IP Environment Setup” on pages 93 to 109 for further information.

### 4. Set up TV features.

On-screen setup menus control the features of the TV. Press **MENU** on the Installer Remote, and select the **All Settings**  menu icon from the Quick Settings Menu to access the advanced TV setup menus. Then, set Picture, Sound, Channels, etc. options to the desired configurations. See “Clonable TV Setup Menu Features” list on page 75 and also notes below.

**Note:** If you intend to use the Zoning feature(s) on this TV, make sure to set the appropriate TV Zone # and/or Wi-Fi Zone # at this time as described in Reference section, “Using the TV’s Zoning Features.” See also note in step 2(c) regarding Hospital Mode and TV Zoning availability.

**Note:** If desired and if appropriate, you can run Channel Tuning (see step 5) prior to completing this step.

### 5. (Optional) Run Channel Tuning.

If you are creating a Master TV Setup for cloning purposes and you want the Target TV(s) to remain in Pass-through Mode or Application Tuning Mode, as applicable, do NOT run Channel Tuning. If you export a Master TV Setup that includes an auto-tuned/edited channel lineup, thereby creating a Clone (.tlx) file with an FTG Channel Map, and then import the Clone file to a Target TV, this will put the Target TV in FTG Mode via CPU.

**Note:** When you import a Clone/Configuration (.tlx) file that contains an FTG Channel Map on a Target TV (for FTG Mode via CPU configuration), depending on the types of channels included in the Channel Map, you may have the option to select either logical or physical channel tuning. For either selection, the channel sequence will be based on the order in which the channels appear in the FTG Channel Map. You can view and/or edit the channel sequence in the Cloud Configuration Tool, as required.

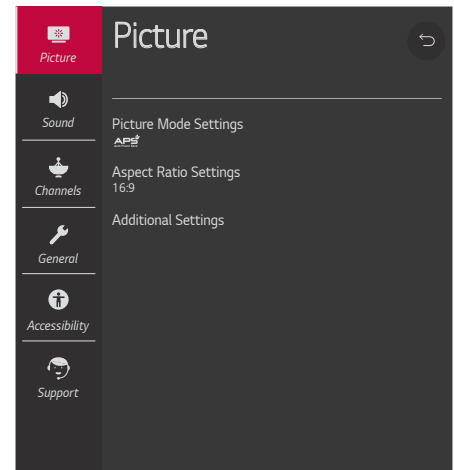

Use the TV setup menus to set the TV features to the desired configuration for the end user. This example illustrates the advanced TV setup menus.

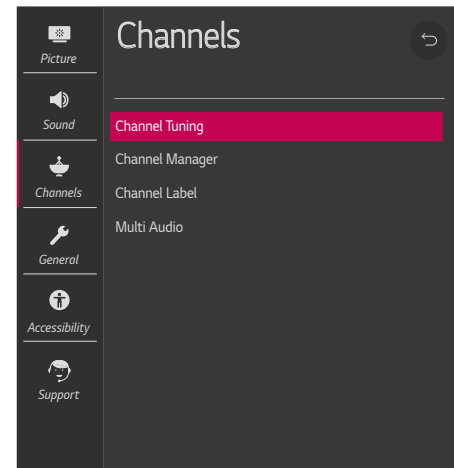

(Optional) Use Channels Menu options to run Channel Tuning and edit the channel lineup.

(Continued on next page)

## Custom Master TV Setup (Cont.)

---

(Continued from previous page)

- a) Use the Installer Remote to access the Channels Menu. Then, select **Channel Tuning** and follow the on-screen instructions to search for all available digital and analog channels.
- b) Use the **Channel Manager** option in the Channels Menu to edit the channel lineup, as necessary. Add/delete channels per your system requirements.

### 6. Verify the TV setup.

Make sure the TV features are set per your requirements. Also, if applicable, verify that the channel lineup is correct.

The Master TV Setup is now ready to be saved (exported) to a USB memory device. See “Cloning Procedures” on pages 79 to 85.

Cloning typically refers to the process of using a Master TV Setup to configure a Target TV. This section describes how to save (export) a Master TV Setup and then transfer (import) it to a Target TV using a USB memory device / Clone (.tlx) file.

You can also create an FTG Configuration (.tlx) file using the Cloud Configuration Tool and then use the Import Clone File procedure to transfer the configuration to Target TVs. Refer to “Creating an FTG Configuration File” on pages 86 to 88, as necessary.

## Exporting a Clone File

This section describes how to use the TV Manager “Export Clone File” option to export Master TV Setup configuration to a USB memory device / Clone (.tlx) file.

### Before You Begin

- Ensure the USB device has been formatted with FAT format.
- If applicable, complete the Custom Master TV Setup procedure (see pages 75 to 78).
- If you would like the Target TV(s) to remain in Pass-through Mode or Application Tuning Mode, as applicable, after the Clone file is imported, ensure the Master TV does not have an auto-tuned/edited channel lineup; otherwise, importing the exported file will result in the Target TV(s) being configured for FTG Mode via CPU.
- If you intend to use the TV’s Zoning feature(s), make sure to set the appropriate TV Zone # and/ or Wi-Fi Zone # as described in Reference section, “Using the TV’s Zoning Features,” BEFORE performing the procedure below. Also, for Wi-Fi Zoning in particular, the TV’s wireless network connection settings should be configured in the IP Environment Menu before exporting is initiated.

**Note:** The TV Zoning feature is only available when Installer Menu item 027 HOSPITAL MODE is set to 0 (i.e., Hospital Mode is disabled). See item 027 description on page 68 for further information.

- It is not possible to clone a Master TV’s clock. Either set a Target TV’s clock manually, or use the Auto Clock setting in the TV setup menus.
- Since the Export Clone File process retrieves the channel lineup from the CPU, if the TV is currently in FTG Mode via EBL (FTG Channel Map resides in EBL), it is not possible to export an FTG Channel Map.



**Caution: Do not unplug the TV power cord or remove the USB memory device while exporting is in progress, as doing so may cause the TV to malfunction or harm the USB device, respectively.**

### Export Clone File Procedure

1. Ensure the Master TV is set up completely and turned ON.
2. Insert the USB memory device into either of the USB ports on the Master TV.
3. Press **MENU** on the Installer Remote to display the TV setup menus (TV is in Pass-through Mode) or the Function Menu (TV is already in FTG Mode).
4. (TV in Pass-through Mode only) From the Quick Settings Menu displayed at the left of the screen, select the **All Settings**  menu icon and press **OK** to access the advanced TV setup menus.

(Continued on next page)

## Cloning Procedures (Cont.)

(Continued from previous page)

5. Use the arrow navigation keys to select/highlight either the **General** menu icon from the TV setup menus or the **Safety** menu icon from the Function Menu. Then, press the number “7” key a total of seven times to access the TV Manager.

**Note:** If a password prompt is displayed (i.e., TV Manager Password Protection is enabled in the IP Environment / General Menu), key in the TV Manager password and press **OK**.

**Note:** Ez Download is always selected by default when you initially access the TV Manager. Also, note that Diagnostics is for service use only.

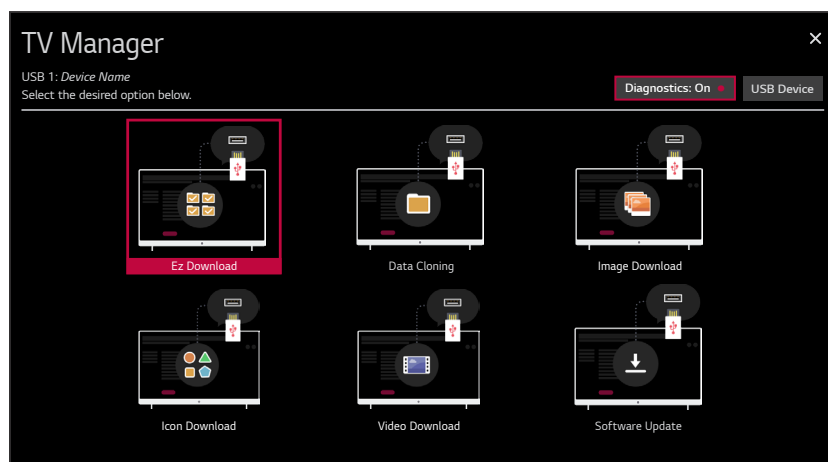

6. If more than one USB memory device is currently connected to the TV, be sure to select the USB device on which you wish to save the Clone file. If necessary, use the arrow keys on the Installer Remote to select/highlight the **USB Device** button in the top right corner of the screen and press **OK**. Then, use the Up/Down arrow keys to select the appropriate USB device from the pop-up list of USB devices.



7. Use the arrow keys to select **Data Cloning**, and then press **OK**.
8. With the Data Cloning screen on display, use the Up/Down arrow keys to select **Export Clone File**, and then press **OK**.  
Clone filename parameters will be displayed on the screen (see example on following page).
9. Modify the filename, as required. While the TV model element of the filename may not be changed, you can differentiate this Clone file from other US772M Clone files by changing the numeric assignment appended to the end of the filename. Select/highlight the filename, and then use the Up/Down arrow keys on the Installer Remote to scroll through numeric assignments until the desired number is shown.

(Continued on next page)



(Continued from previous page)

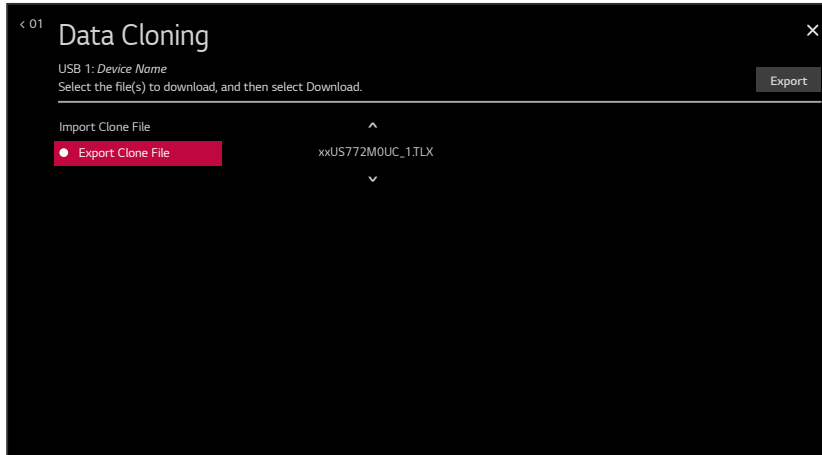

10. When you are ready to continue, i.e., when you have selected the desired filename, press **OK** on the Installer Remote to select/activate the **Export** button at the top right of the screen, and then press **OK** on the Installer Remote once more to export the file.

Export progress will be displayed on the screen. This process may take a few minutes. Do NOT remove the USB device while exporting is in progress. When the export process is complete, an "Export Clone File is completed" pop-up message will be displayed on the screen.

**Note:** While the Clone file is exported, a second file, with a ".dzm" file extension, is automatically created and stored on the USB device as well. This feature is intended to facilitate the process of configuring additional US772M TVs using the same USB device / exported Clone file. When this USB device is connected to a US772M TV with the First Use Wizard / Welcome screen on display, a pop-up window will enable you to proceed directly to the TV Manager / Ez Download utility.

11. Press **OK** to return to the TV Manager / Data Cloning screen. To return to program viewing, select the **X** button at the top right corner of the screen.
12. Remove the USB memory device from the Master TV.



**Note:** If the Master TV has a channel lineup, during the export process, logical channel numbers are automatically assigned in ascending order, starting with 0 (zero), to the physical RF channels of the TV channel lineup to create an FTG Channel Map. See also note below.



**Note:** If the exported Clone file is to be used for FTG Mode via CPU configuration (i.e., it contains an FTG Channel Map), it is highly recommended that you open the file in the Cloud Configuration Tool—BEFORE transferring (importing) the file to any Target TVs—to verify FTG Channel Map and FTG Installer Menu settings. This will also enable you to confirm channels and add channel attributes, labels, etc.

# Cloning Procedures (Cont.)

---

## Importing a Clone File

This section describes how to transfer (import) a Clone or Configuration (.tlx) file from a USB memory device to a TV using the TV Manager “Import Clone File” option. The “.tlx” file may be created either from a Master TV Setup that was saved (exported) from a Master TV or in the Cloud Configuration Tool.

### Before You Begin

- Ensure the USB device has been formatted with FAT format.
- Avoid using special characters, such as ?, &, @, etc., in the Clone/Configuration (.tlx) filename.
- If you have initiated the Advanced Settings / EZ-Manager Wizard, you can use the wizard’s “USB Configuration” option to access the TV Manager and complete the import procedure (see “TV Configuration Options” and/or “USB Configuration” on pages 43 and 54, respectively, as necessary).
- You may also use the Ez Download utility to import the Clone/Configuration (.tlx) file. See “Ez Download Utility” on pages 56 to 60 for further information.
- If the Target TV is currently in Pass-through Mode and you intend to use the TV’s Zoning feature(s)—i.e., the Clone/Configuration (.tlx) file you are importing contains an FTG Channel Map and/or FTG profile(s) with TV Zone and/or Wi-Fi Zone assignments—make sure to set the appropriate TV Zone # and/or Wi-Fi Zone # in the TV when directed to do so in the procedure below. See Reference section, “Using the TV’s Zoning Features,” for further information.

**Note:** The TV Zoning feature is only available when Installer Menu item 027 HOSPITAL MODE is set to 0 (i.e., Hospital Mode is disabled). See item 027 description on page 68 for further details.

- If you would like the Target TV(s) to remain in Pass-through Mode or Application Tuning Mode, as applicable, after the Clone/Configuration (.tlx) file is imported, ensure the “.tlx” file does not contain an FTG Channel Map; otherwise, the import procedure will result in the Target TV(s) being configured for FTG Mode via CPU.
- If a Clone (.tlx) file (exported Master TV Setup) contains an FTG Channel Map, the physical RF channels in the FTG Channel Map have been assigned logical channel numbers (see “Exporting a Clone File” above). When you import the Clone file with the FTG Channel Map on the Target TV(s), you will have the option to select either logical or physical channel tuning. Even if you select physical channel tuning, the (list of) physical RF channels in the FTG Channel Map will remain in logical order.
- If an FTG Configuration (.tlx) file (created in the Cloud Configuration Tool) contains an FTG Channel Map, each logical channel number in the FTG Channel Map has been assigned a physical RF channel, an IP channel, or an Aux input (the latter designated by 130-0 through 137-0—see also Reference section, “TV Aux Input Configuration”).

**Note:** If the FTG Channel Map includes RF channels and Aux inputs *only*, when you import the FTG Configuration file on the Target TV(s), you will have the option to select either logical or physical channel tuning. If you select physical channel tuning, the physical RF channels and Aux inputs in the FTG Channel Map will remain in logical order. Physical channel tuning is not available when the FTG Channel Map includes IP channels.

- If the Target TV EBL is already in FTG Mode, you cannot use this procedure to make changes to the FTG Channel Map and FTG Installer Menu settings. You must use a direct PC-to-TV connection as described in Reference section, “FTG Mode via EBL (Local Configuration),” or an FMA head end device to reconfigure the EBL.
- If the preceding condition applies, but you wish to switch the TV to FTG Mode via CPU, see Reference section, “Restoring Factory Defaults on the TV(s),” for further information before proceeding.
- If the Clone/Configuration (.tlx) file was edited/created in the Cloud Configuration Tool, it may contain multiple zoned FTG Installer Menu profiles for different TV models. Make sure it includes the appropriate Installer Menu profile(s) for the Target TV(s) before proceeding.



**Caution: Do not unplug the TV power cord or remove the USB memory device while importing is in progress, as doing so may cause the TV to malfunction or harm the USB device, respectively.**

### Import Clone File Procedure

1. Turn ON the Target TV.
2. The next step depends on whether the First Use Wizard appears on the screen when you turn ON the TV:
  - If the wizard is displayed, you can complete the import procedure via the Advanced Settings / EZ-Manager Wizard, as indicated above (see “Before You Begin”). However, to continue with this procedure and access the “Import Clone File” option from the TV menus, exit the First Use Wizard. Then, continue with step 3.
  - If the wizard is not displayed, go directly to step 3.
3. If applicable (see also “Before You Begin” above), make sure to set the appropriate TV Zone # and/or Wi-Fi Zone # in the Target TV at this time.



**Note: In order for the proper TV Zone and/or Wi-Fi Zone profile data to be applied, the appropriate TV Zone # and/or Wi-Fi Zone # must be set in the Target TV BEFORE importing is initiated.**

4. Insert the USB memory device with the Clone/Configuration (.tlx) file into either of the USB ports on the Target TV.
5. Press **MENU** on the Installer Remote to display the TV setup menu (TV is in Pass-through Mode) or the Function Menu (TV is already in FTG Mode).
6. (TV in Pass-through Mode only) From the Quick Settings Menu displayed at the left of the screen, select the **All Settings**  menu icon and press **OK** to access the advanced TV setup menus.
7. Use the arrow navigation keys to select/highlight either the **General** menu icon from the TV setup menu or the **Safety** menu icon from the Function Menu. Then, press the number “7” key a total of seven times to access the TV Manager.

**Note:** If a password prompt is displayed (i.e., TV Manager Password Protection is enabled in the IP Environment / General Menu), key in the TV Manager password and press **OK**.

**Note:** Ez Download is always selected by default when you initially access the TV Manager. Also note that Diagnostics is for service use only.

(Continued on next page)

# Cloning Procedures (Cont.)

(Continued from previous page)

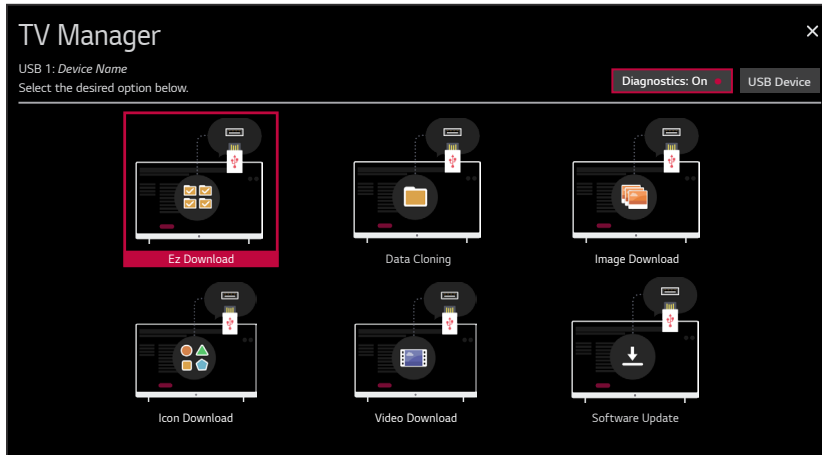

8. If more than one USB memory device is currently connected to the TV, be sure to select the USB device that contains the “.t1x” file you wish to use. If necessary, use the arrow keys on the Installer Remote to select/highlight the **USB Device** button in the top right corner of the screen and press **OK**. Then, use the Up/Down arrow keys to select the appropriate USB device from the pop-up list of USB devices.

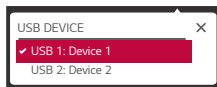

9. Use the arrow keys to select **Data Cloning**, and then press **OK**.  
When the Data Cloning screen is initially displayed, the “Import Clone File” option is selected by default, and a list of the “.t1x” files stored in the root folder of the USB memory device is displayed on the screen.

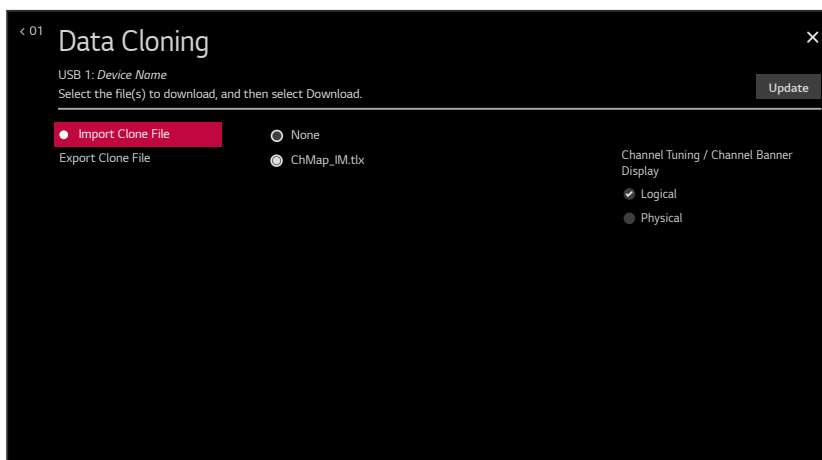

(Continued on next page)

(Continued from previous page)

10. Use the arrow keys on the Installer Remote to select/highlight the “.tlx” file to import, and then press **OK**.

**Note:** Filenames of exported Clone files are comprised of the TV model and a numeric element, for example, xxUS772M0UC\_1.TLX.

11. If the Clone/Configuration (.tlx) file includes an FTG Channel Map with RF channels and Aux inputs *only*, you can choose the format for the channel tuning/banner display. Use the arrow keys to select the desired Channel Tuning / Channel Banner Display option—either Logical or Physical—at the right side of the screen. A checkmark will appear at the left of the selected option. Logical tuning is selected by default.

**Note:** If an FTG Channel Map includes IP channels, only logical tuning is available. Also, if the “.tlx” file does not include an FTG Channel Map, the message, “No Channel Map in Clone file,” will be displayed at the right of the screen.

12. When you are ready to continue, select **Update** on the screen and then press **OK** on the Installer Remote.

Import progress will be displayed on the screen. This process may take a few minutes. Do NOT remove the USB device while importing is in progress. When the import process is complete, an “Import Clone File is completed” pop-up message will briefly be displayed on the screen, and then, the TV will reboot.

13. Remove the USB memory device from the Target TV, and verify that the appropriate configuration is now resident on the Target TV.

**Note:** If the Target TV was previously in Pass-through Mode, and the Clone/Configuration (.tlx) file that was imported contained an FTG Channel Map, the Target TV CPU is now in FTG Mode. Upon restart, the TV tunes according to the Start Channel setting in the Installer Menu. If a Start Channel is specified, the TV will tune to that channel, though, in the case of FTG Mode via CPU configuration, a channel banner will only be displayed if the Start Channel is included in the FTG Channel Map (depending on your selection in step 11, the channel banner will display either the Start Channel’s logical channel number or physical RF channel number). Otherwise, the TV will either return to the last channel tuned (TV in Pass-through Mode) or tune to the first channel in the FTG Channel Map (TV in FTG Mode via CPU). If the latter, remember that the channels in the FTG Channel Map are always arranged in logical order, regardless of your selection in step 11.

# Cloud Configuration Tool Overview

As indicated in the introduction to this document, there are two separate and distinct methods for configuring US772M TVs for FTG Mode of operation: one method is to configure the TV CPU for FTG Mode operation, while the other is to configure the TV EBL for FTG Mode operation. FROM A LOCAL CONFIGURATION STANDPOINT, EACH OF THESE METHODS IS MUTUALLY EXCLUSIVE. IF THE CPU IS IN FTG MODE, THE EBL CANNOT BE SWITCHED TO FTG MODE. LIKEWISE, IF THE EBL IS IN FTG MODE, THE CPU CANNOT BE SWITCHED TO FTG MODE.

This section provides an overview of LG's Cloud Configuration Tool web application, which is used for FTG Mode via CPU configuration. For best results, it is recommended that you access the Cloud Configuration Tool using one of the following web browsers: Google Chrome™ 51 or later or Mozilla Firefox® 47 or later.

## Creating an FTG Configuration File

The subsections below briefly describe how to use the Cloud Configuration Tool to create an FTG Configuration (.tx) file that can be used to configure the TV for FTG Mode via CPU. The Cloud Configuration Tool provides options both for advanced and new users. If you are not familiar with the steps to create an FTG Configuration file, you may choose a Wizard Setup that will guide you through the process of creating a new file. Refer to the **Cloud Configuration Tool User Guide** for further information.

**Note:** There is also an option to save (export) configuration from a TV, which may be desirable or required if you want to save customized TV setup menu settings to the FTG Configuration file and/or if you do not know the RF channels at the site. See "Exporting a Clone File" on pages 79 to 81 for further information.

## Access the Cloud Configuration Tool and Select a Setup Option

1. Launch a web browser, and navigate to the following URL: **cct.procentric.tv**.
2. On the Welcome web page, make sure **North America** (default) is selected in the Select Your Region field, and then click on the **SELECT** button at the right of the field.

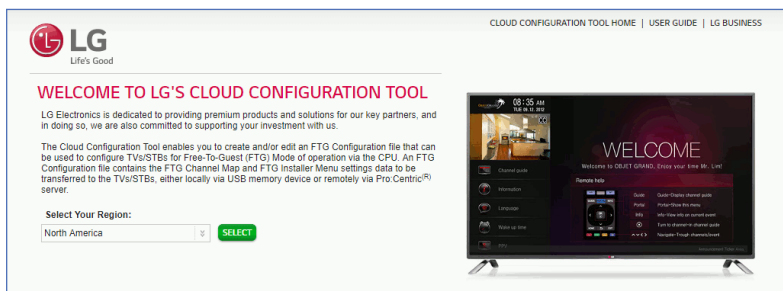

3. Once you select your region, you can choose the desired setup option, depending on your familiarity with the utilities and/or your file requirements:

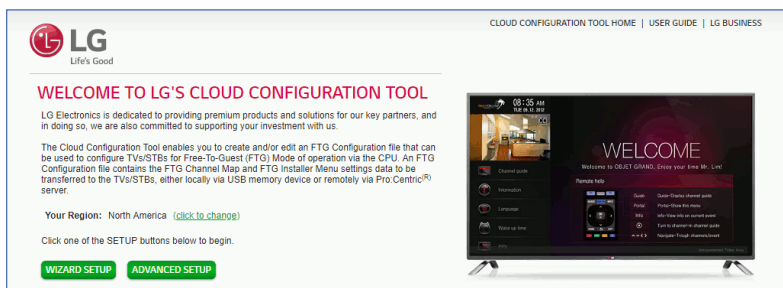

(Continued on next page)

# Cloud Configuration Tool Overview (Cont.)

---

(Continued from previous page)

- If you are creating an FTG Configuration file from scratch and this is your first time using the Cloud Configuration Tool, you may wish to select the Wizard Setup, which will guide you through the essential steps of creating the file, i.e., creating the FTG Channel Map and/or the Installer Menu profile(s). To initiate the Wizard Setup, click on the **WIZARD SETUP** button.

On the next wizard page you will be prompted to indicate whether you would like to create an FTG Channel Map. Note that an FTG Channel Map is required for FTG Mode operation. Once you complete (or bypass) Channel Map activities and proceed to the next step, you will be prompted to indicate whether you would like to create an Installer Menu profile. The final wizard step enables you to review a summary of the FTG Configuration (.tlx) file contents and then save (export) the file to your PC.

- To view and/or base a new FTG Configuration file on an existing FTG Configuration (.tlx) file, or if you do not require wizard guidance to complete your activities, click on the **ADVANCED SETUP** button.

The File Manager web page will be displayed, and you have a number of options.

The following procedure provides an overview of the Advanced Setup. Refer to the **Cloud Configuration Tool User Guide** for further information on both the Wizard Setup and the Advanced Setup.

## Advanced Setup Overview

1. When you select **ADVANCED SETUP** from the Welcome page (see “Access the Cloud Configuration Tool and Select a Setup Option” above), the File Manager page is displayed (see example on page 89).
2. (Optional) If desired/appropriate, you may view and/or base the new FTG Configuration file on an existing FTG Configuration (.tlx) file:

- Click on the **BROWSE** button at the right of the Find File to Upload field, and select/double-click on the desired “.tlx” file. Then, click on the **UPLOAD** button below the Find File to Upload field.

Once the file is successfully uploaded, the Find File to Upload field is replaced with a Loaded From File summary of the file’s contents, including a Channel Map Summary, Installer Menu Summary, and Setup Menu Summary.

- Double-click on each item in the Loaded From File summary at the left of the page that you would like to copy to the FTG Configuration List at the right of the page. As you move your mouse over the contents of a summary field, the field will be highlighted in blue, and  arrows at the right of the field will indicate that the data may be copied to the FTG Configuration List.
- Edit the configuration of the items in the FTG Configuration List as well as the FTG Configuration List itself, as necessary, to create a new file.

**Note:** While Setup Menu profiles can be included in the new FTG Configuration file (i.e., the profile[s] can be copied to the FTG Configuration List), Setup Menu profiles are not available for editing. However, on the File Manager page, you may change the Zone assignment for a Setup Menu profile, as required, for those models on which the TV Zoning feature is supported.

**Note:** If desired, you can click on the **UPLOAD NEW FILE** button below the list of Loaded From File items to select a different existing FTG Configuration file. If you want to add Installer Menu and/or Setup Menu profiles from more than one existing file to the new FTG Configuration file, make sure to transfer the appropriate items from the currently uploaded file to the FTG Configuration List before uploading a different file.

(Continued on next page)



# Cloud Configuration Tool Overview (Cont.)

---

(Continued from previous page)

3. If you need to edit the FTG Channel Map from an existing file (see previous step) or create a new FTG Channel Map, click on **CHANNEL MAP** in the menu options bar at the top left of the page to access the Channel Map web page (see example on page 90), and edit/create the FTG Channel Map. Up to 600 logical channels—combined total of both RF and IP mapped channels—can be defined in the FTG Channel Map.
4. (Optional) To load default FTG Installer Menu settings by model, click on **INSTALLER MENU** in the menu options bar at the top left of the page to access the Installer Menu web page (see example on page 92), select the desired model/chassis ID and the desired Zone, and then click on the **CREATE PROFILE** button to create a new profile.

The new model profile will be added to the Installer Menu Profile List at the top right of the page, and the Installer Menu items for the selected model will now be displayed on the lower half of the page. The Summary tab shows the features that are available for configuration. Click on any Installer Menu item in the Summary tab or a category tab (User, Tuning, Audio, etc.) to view and/or edit its parameters, as required.

**Note:** Unless you select a different Zone assignment when you create the new profile, the default Zone 0 is assigned automatically. See Reference section, “Using the TV’s Zoning Features,” for further information on the TV Zoning feature and setting the TV Zone # in the TV(s), though also note that the TV Zoning feature is only available when Installer Menu item 027 HOSPITAL MODE is set to 0 (i.e., Hospital Mode is disabled). See item 027 description on page 68 for further information.

5. Click on **FILE MANAGER** in the menu options bar at the top left of the page to return to the File Manager web page. The FTG Configuration List will now be populated with summaries of the FTG Channel Map, FTG Installer Menu profile(s), and, if applicable, Setup Menu profile(s) you created or added in the previous steps. Review and edit the FTG Configuration List, as necessary.

**Note:** If you need to edit the Channel Map or an Installer Menu profile, double-click on the desired item to access the Channel Map page or the Installer Menu page, as applicable. When you return to the File Manager page, the FTG Configuration List is automatically updated with all Channel Map and Installer Menu changes. (Installer Menu and/or Setup Menu profile Zone assignments may be changed on the File Manager page.)

**Note:** To remove an individual item from the FTG Configuration List, click on the **X** at the right of the applicable item. At the prompt for confirmation , either click **yes** to confirm and remove the item immediately, or click **no** to retain the item. To clear all current FTG Configuration List contents, click on the **CLEAR LIST** button at the bottom right of the FTG Configuration List.

6. Export the FTG Configuration List contents to an FTG Configuration (.tlx) file on the PC’s hard drive for later use:

- Type a brief descriptive name in the File Name field at the bottom of the FTG Configuration List (avoid using special characters, such as ?, &, @, etc.).
- Click on **EXPORT FILE**.
- In the Save As window (if applicable—see note below), select the desired location to which to export the file (you can also edit the file name here, if necessary), and click **Save**.

**Note:** Depending on the browser you are using and its current settings, files may automatically be saved to the “Downloads” or another designated folder on your PC. If you want to be able to select the folder in which to save the FTG Configuration file, check your browser settings.

7. Transfer the FTG Configuration (.tlx) file to a USB memory device, and proceed to “Importing a Clone File” on pages 82 to 85 to transfer the FTG Configuration file to a US772M TV.

# Cloud Configuration Tool Overview (Cont.)

## File Manager Web Page Overview

The File Manager page (displayed after you select ADVANCED SETUP from the Welcome page) enables you to compile, modify, and save (export) FTG Configuration (.tlx) files. The following example provides an overview reference of the functions available on the File Manager page.

Data contained in uploaded FTG Configuration (.tlx) file. Users may choose to copy some or all of this data to the FTG Configuration List.

Data to be saved in the FTG Configuration (.tlx) file. This data may include contents transferred from an uploaded file and/or Channel Map/ Installer Menu contents created or modified in the Cloud Configuration Tool.

The screenshot shows the File Manager interface with the following elements and annotations:

- Cloud Configuration Tool menu bar:** Located at the top, it includes 'FILE MANAGER', 'INSTALLER MENU', and 'CHANNEL MAP'. A callout states: "Cloud Configuration Tool menu bar provides access to all utilities."
- Upload Section:** Features a "Find file to upload:" input field with a "BROWSE" button and an "UPLOAD" button. A callout points to this section: "Data contained in uploaded FTG Configuration (.tlx) file. Users may choose to copy some or all of this data to the FTG Configuration List."
- Loaded from File Panel:** Displays data from an uploaded file, including "Channel Map Summary" (0 Mapped RF Channels, 0 Mapped IP Channels), "Installer Menu Summary (1 profile)" (Zone: 0 - Model: 55/65US772M (0 items modified)), and "Setup Menu Summary" (empty). A callout points to this panel: "Data to be saved in the FTG Configuration (.tlx) file. This data may include contents transferred from an uploaded file and/or Channel Map/ Installer Menu contents created or modified in the Cloud Configuration Tool."
- FTG Configuration List Panel:** Mirrors the data from the "Loaded from File" panel. A callout points to this panel: "Data to be saved in the FTG Configuration (.tlx) file. This data may include contents transferred from an uploaded file and/or Channel Map/ Installer Menu contents created or modified in the Cloud Configuration Tool."
- Export/Save Section:** Includes a "File name:" input field (containing "FTG\_Configuration.tlx"), an "EXPORT FILE" button, and a "CLEAR LIST" button. A callout points to this section: "Save (export) or reset (i.e., clear) the FTG Configuration List."
- Upload New File Button:** A green "UPLOAD NEW FILE" button. A callout points to it: "Upload a new file, as required."
- File Name Input:** A callout points to the "File name:" field: "The name of the new FTG Configuration file to be created."

Copyright © 2020 LG Electronics. All Rights Reserved. PRIVACY | LEGAL | LG CORPORATE

# Cloud Configuration Tool Overview (Cont.)

## Channel Map Web Page Overview

On the Channel Map page, you can create, view, and edit a Logical Channel Map.

Search for existing channels or clear the FTG Channel Map.

(Advanced Setup only) Cloud Configuration Tool menu bar provides access to all utilities.

Click the appropriate button to add a new RF or IP channel to the FTG Channel Map.

(Wizard Setup only) Proceed to next step.

The screenshot shows the 'CHANNEL MAP' web page. At the top, there is a navigation bar with 'FILE MANAGER', 'INSTALLER MENU', and 'CHANNEL MAP'. Below this is a search bar labeled 'CHANNEL MAP Search: (enter Logical or Label)' with a 'CLEAR CHANNEL MAP' button. To the right of the search bar are two buttons: 'RF CHANNEL' and 'IP CHANNEL'. Further right is a 'NEXT STEP' button. The main content is a table with the following columns: Logical, Channel Logo, Label, RF IP Address, Major IP Type, Minor IP Port, PLP ID, Prog #, Source Address, Attribute, Restricted from Zones, and Actions. The table contains several rows of channel data, including CBS, NBC, CNN, ABC, PBS, History, Discovery, and Video. The 'Video' row is highlighted with a box around its 'Label' column. At the bottom of the page, there is a copyright notice: 'Copyright © 2023 LG Electronics. All Rights Reserved. PRIVACY | LEGAL | LG CORPORATE'.

Logical	Channel Logo	Label	RF IP Address	Major IP Type	Minor IP Port	PLP ID	Prog #	Source Address	Attribute	Restricted from Zones	Actions
1	CBS	CBS	2	2	0				Encrypted OSD	No	[Edit] [Delete]
2	NBC	NBC	20	20	5				Encrypted OSD	No	[Edit] [Delete]
3	CNN	CNN	81	81	1				Encrypted OSD	No	[Edit] [Delete]
4	ABC	ABC	18	18	1				Encrypted OSD	No	[Edit] [Delete]
5	PBS	PBS	19	19	3				Encrypted OSD	No	[Edit] [Delete]
6	History	History	86	86	2				Encrypted OSD	No	[Edit] [Delete]
7	Discovery	Discovery	58	58	2				Encrypted OSD	No	[Edit] [Delete]
91	no logo	Video	72	72	47				Encrypted OSD	No	[Edit] [Delete]
93	no logo	HDMI 1	133	133	0				Encrypted OSD	No	[Edit] [Delete]

This example shows how to define an Aux input in the FTG Channel Map. See also Reference section, "TV Aux Input Configuration."

Click the appropriate icon to either edit an existing Logical Channel's data (see below) or remove a channel from the FTG Channel Map.

# Cloud Configuration Tool Overview (Cont.)

The following example illustrates the fields that define the channel.

Select a channel logo (select "No Logo" if applicable), and/or enter a custom channel label.

As applicable, assign the RF, Major, and Minor channel numbers and PLP ID or enter the IP Address, Type, IP Port, and Program # data for the channel.

Set Zone restriction(s) per channel. Zones you select will be listed in the Restricted from Zones column. See also note below.

Logical	Channel Logo	Label	RF	Major	Minor	PLP ID	IP Address	IP Type	IP Port	Program #	Source Address	Attribute	Restricted from Zones	Actions
0	no logo	17 Character Limit	1	1	0		ATSC 3.0					<input checked="" type="checkbox"/> Encrypted <input checked="" type="checkbox"/> OSD <input type="checkbox"/> Blank Video	<input type="checkbox"/> Zone 1 <input type="checkbox"/> Zone 2 <input type="checkbox"/> Zone 3 <input type="checkbox"/> Zone 4 <input type="checkbox"/> Zone 5 <input type="checkbox"/> Zone 6 <input type="checkbox"/> Zone 7 <input type="checkbox"/> Zone 8	<input type="button" value="SAVE"/> <input type="button" value="CANCEL"/>

Enter a logical channel number.

Set channel attributes. Check/select Encrypted, OSD, or Blank Video.

After adding a new channel or editing an existing channel, save or cancel the changes.



**Note:** The application of FTG Channel Map Zone restrictions in the TV (see Restricted from Zones field in this screen) depends on the setting of Installer Menu item 027 HOSPITAL MODE (see item 027 description on page 68 for further details). If Installer Menu item 027 is set to 0, Hospital Mode is disabled, and TV Zoning / FTG Channel Map Zone restrictions may be set, as in Lodging models (see also Reference section, "Using the TV's Zoning Features"). When Hospital Mode is enabled, you can use Zones 1 to 4 to create custom channel lineups for channel banks 1 to 4 (see also "Channel Banks Overview" on pages 40 to 42). In the latter case, a checked Zone Restriction (1 to 4) checkbox means that the selected channel is "deleted" from the same numbered channel bank.

# Cloud Configuration Tool Overview (Cont.)

## Installer Menu Web Page Overview

(Advanced Setup only) Cloud Configuration Tool menu bar provides access to all utilities.

Load default Installer Menu for selected model. Assign Zone as applicable. Once you click on CREATE PROFILE, this Installer Menu profile will be listed under the Installer Menu Profile List, and Installer Menu items will be displayed on the lower half of the page.

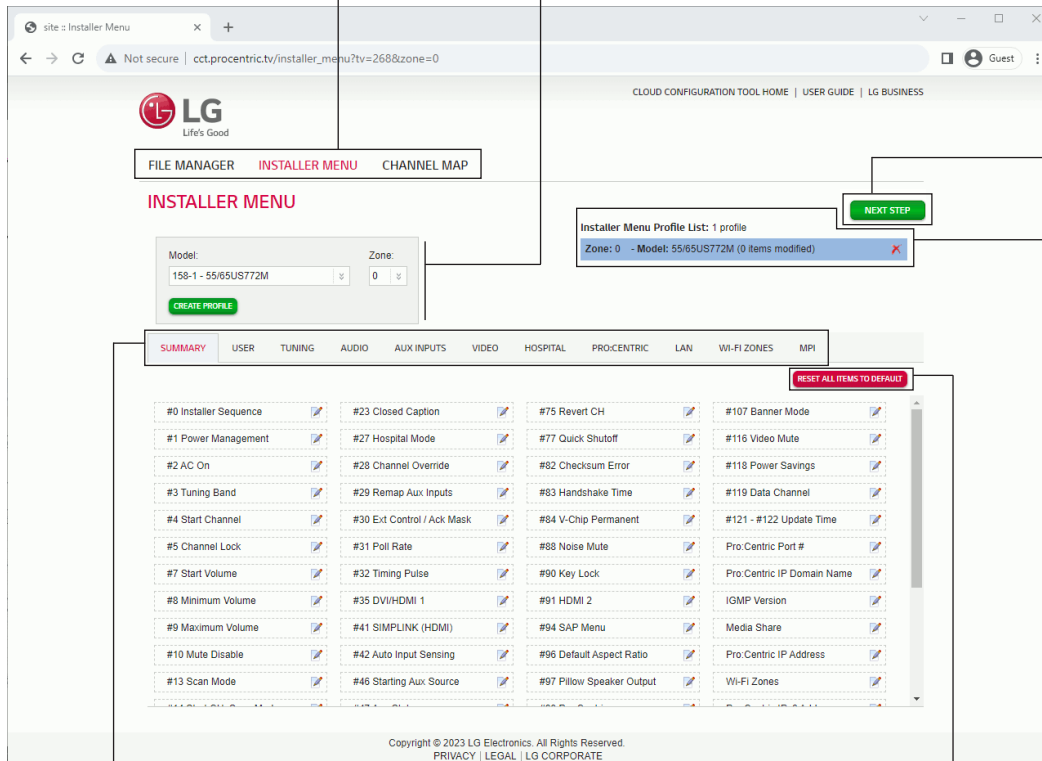

(Wizard Setup only) Proceed to next step.

Installer Menu profiles to be included in the FTG Configuration (.tlx) file. The currently active profile is highlighted.

Select tabs for categories of Installer Menu items to set up TV.

Reset default values for currently active configuration profile. A RESET button is also available within each category tab.

**Note:** The Pro:Centric tab enables you to set up Pro:Centric-specific parameters, the LAN tab enables you to set up a variety of LAN features, and the Wi-Fi Zones tab enables you to set up Wi-Fi Zones. Refer to the **Cloud Configuration Tool User Guide** for further information. Also, see Reference section, "Using the TV's Zoning Features," for additional information on Wi-Fi Zoning.

The IP Environment Menu enables you to set up the network features of the TV. If you intend to create a Master TV Setup for cloning purposes (see Master TV Setup procedure on pages 75 to 78), all IP Environment settings, with the exception of wired network (Ethernet) settings, LG Connect settings, Pro:Centric Cloud settings, General Menu settings, the TV name (editable in the Media Share Menu), and SoftAP settings, may be cloned.

**Note:** With the exception of network settings, Pro:Centric Cloud settings, and General Menu settings, the IP Environment settings are editable (with the Installer Remote) only if the TV is in Pass-through Mode and read-only when the TV is not in Pass-through Mode.

## Accessing the IP Environment Menu

The IP Environment Menu is accessible from the First Use Wizard or from the Installer Menu. For information on accessing the IP Environment Menu from the First Use Wizard, see “First Use Wizard” on pages 19 to 21. The steps below describe how to access the IP Environment Menu from the Installer Menu.

**Note:** When you enter the IP Environment Menu, the Installer Menu is exited (all current settings are saved automatically upon exit). If you are also in the process of updating Installer Menu items, you may wish to set all items as needed before you access the IP Environment Menu. Otherwise, after exiting the IP Environment Menu, you will need to reaccess the Installer Menu to set additional items.

1. Use the Installer Remote to access the Installer Menu (see “Accessing the Installer Menu” on page 61 for further information).
2. Navigate to Installer Menu item 119 DATA CHANNEL, and press **2-5-3 + MENU** to launch the IP Environment Menu.

Use the Up/Down arrow keys on the Installer Remote to select the desired menu option and then press **OK**. Refer to the following sections for information on each of the IP Environment setup options.

**When you have completed your IP Environment configuration as required**, press **EXIT** or **↵** on the Installer Remote to exit the IP Environment Menu.

## Network Configuration

This section describes each of the options available in the Network Menu (see example at right). Refer to the appropriate subsection(s) on the following pages.

 **Note: If you intend to use the Wi-Fi Zoning feature with cloning configuration, you must configure the wireless network connection as part of the Master TV Setup. See “Configuring a Wi-Fi Network Connection” on pages 95 to 96 for further information.**

### Accessing the Network Menu

With the IP Environment Menu on display, use the arrow keys on the Installer Remote to select the **Network** menu option. Then, press **OK**.

**Note:** The TV’s MAC address is displayed at the top of the Network Menu screen and cannot be modified.

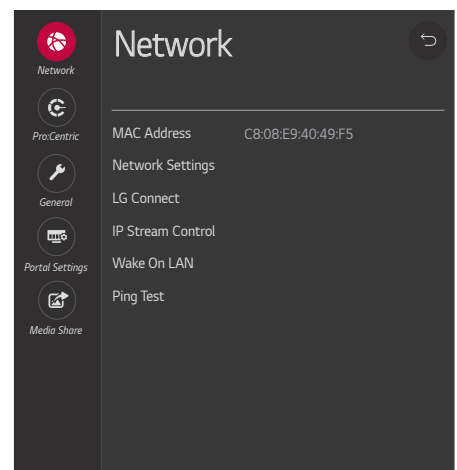

# IP Environment Setup (Cont.)

## Configuring a Wired Network Connection

**Note:** If desired, you can configure both wired and wireless connections to the Local Area Network (LAN). However, note that a wired connection is always prioritized over a wireless connection. That is, if an Ethernet cable is connected between the network and the TV's LAN port, the TV will default to the wired connection. If the Ethernet cable is removed, the TV will then attempt to establish the wireless connection. Whenever the Ethernet cable is reconnected to the TV's LAN port, the TV will re-establish the wired connection.

1. Connect the appropriate cable between the TV and the network.
2. With the Network Menu on display, use the arrow keys on the Installer Remote to select **Network Settings**. Then, press **OK**. A Network Settings screen (see example at right), with Wired and Wi-Fi Connection setup options, will be displayed.

By default, the TV uses DHCP, and if a LAN is detected, the TV will request an IP address from the DHCP server on the network as soon as you select "Network Settings." If the TV is able to connect to the network, a "Connected to Internet" message will appear below the Wired Connection (Ethernet) field.

3. If the network is not configured for DHCP, or if you want to enable/disable IPv6, specify static IP configuration data (applicable only for IPv4), or change the network configuration from Manual to Automatic, select **Wired Connection (Ethernet)** and press **OK**.

In the Wired Connection (Ethernet) screen, you can change the IPv6 status and/or edit the IPv4 data for this TV.

4. To enable/disable IPv6, select/highlight the IPv6 field and press **OK**. Then, select **Enabled** or **Disabled** from the drop-down list of options, as applicable.
5. To edit/specify static IPv4 data or change the network configuration from Manual to Automatic, use the arrow keys on the Installer Remote to select **Edit** at the bottom of the screen and press **OK**. Then, in the Edit screen:
  - Select or de-select the "Set Automatically" checkbox, as required. A checkmark indicates that Automatic configuration is enabled.
  - To manually edit the IPv4 data, for each data entry field: Use the arrow keys on the Installer Remote to select the field and press **OK**. You can use the number keys on the Installer Remote to direct enter numeric values or use the arrow keys to select the appropriate characters from the pop-up virtual keyboard displayed at the bottom of the screen. When you are done, select **Enter** from the virtual keyboard, and then press **OK** on the Installer Remote.

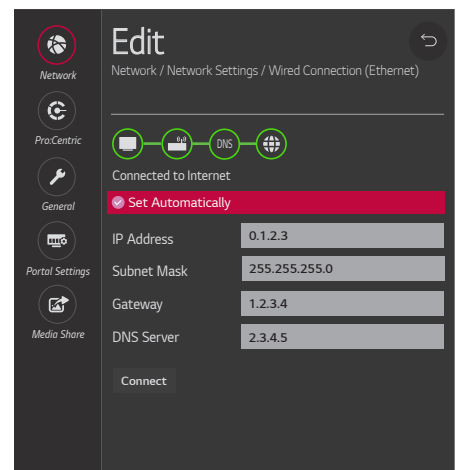
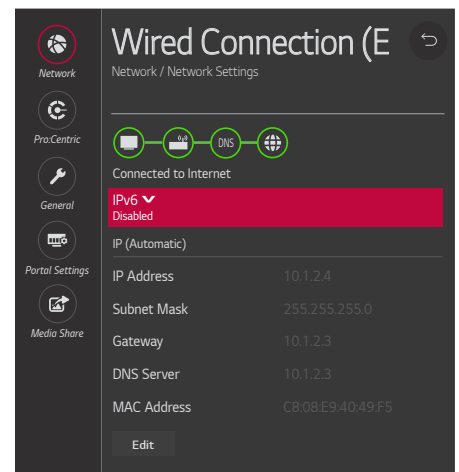
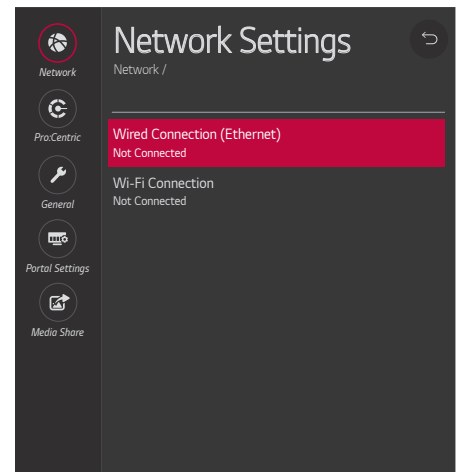

(Continued on next page)



(Continued from previous page)

**Note:** You must use the dot “.” key from the virtual keyboard to separate each octet of an IP address.

- When all Edit fields are set as required, use the arrow keys on the Installer Remote to select **Connect** and press **OK**.

At the top of the screen, you will see a progress display that indicates status as each network element is confirmed (see example on previous page).

If the network is connected successfully, a “Connected to Internet” message will appear just below the progress display. If the network connection is not successful, the progress display will identify the network element in which the connection failed. Check your cabling and/or verify the configuration data, as necessary.

6. When you are finished, use the arrow keys on the Installer Remote to return to the IP Environment Menu, as necessary, or press **↵** to return to the previous Network Menu level(s) and/or exit the IP Environment Menu.

## Configuring a Wi-Fi Network Connection

1. With the Network Menu on display, use the arrow keys on the Installer Remote to select **Network Settings**. Then, press **OK**.
2. A Network Settings screen (see example at right), with Wired and Wi-Fi Connection setup options, will be displayed. Select **Wi-Fi Connection** and press **OK**.
3. The Off/On toggle button at the top right of the Wi-Fi Connection screen (see example on following page) enables you to turn Wi-Fi on or off. The remaining steps of this procedure require that Wi-Fi is turned on. Thus, if necessary, highlight/select the toggle button, and press **OK** to turn on Wi-Fi.
4. Available access points are listed in the top half of the screen, while additional menu options are listed below. Use the arrow keys on the Installer Remote to select the desired access point, or select the type of wireless connection to configure (see descriptions below). Then, press **OK**.
  - Hidden network: Direct enter the SSID—up to 32 characters—of an access point whose SSID has not been enabled for broadcast (i.e., the access point does not appear in the list of access points).
  - WPS PBC: Connect to a network via an access point that is enabled for PBC.
  - WPS PIN: Complete network/PIN verification via the access point web interface.

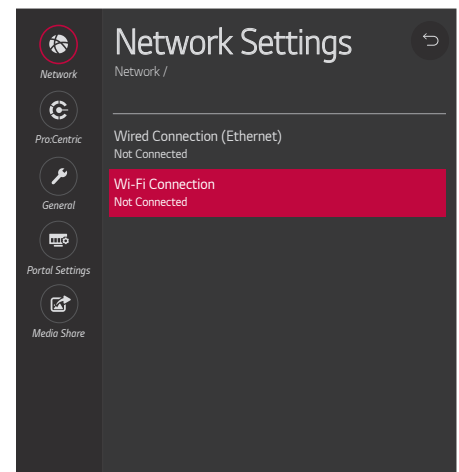

(Continued on next page)

# IP Environment Setup (Cont.)

(Continued from previous page)

Make sure you have the network security password—at least eight, but no more than 32 characters—or PIN available if you are attempting to connect to a secured network.

5. Follow the on-screen instructions to complete the appropriate network configuration. Use the Installer Remote to navigate between fields and make entries, etc.

**Note:** As with a wired connection, you will have the option to enable/disable IPv6 or specify static IPv4 configuration data for this network connection. Once the initial connection is established, you can select **Advanced Wi-Fi Settings** (initially greyed out) at the bottom of the Wi-Fi Connection screen to view the IP configuration data. In the Advanced screen, select **Edit** and press **OK**, and then change the IPv6 status and/or modify the IP data, as required. See steps 4 and 5 of the wired connection procedure above for further information on the Edit screen fields.

6. When you are finished, use the arrow keys on the Installer Remote to return to the IP Environment Menu, as necessary, or press **↵** to return to the previous Network Menu level(s) and/or exit the IP Environment Menu.

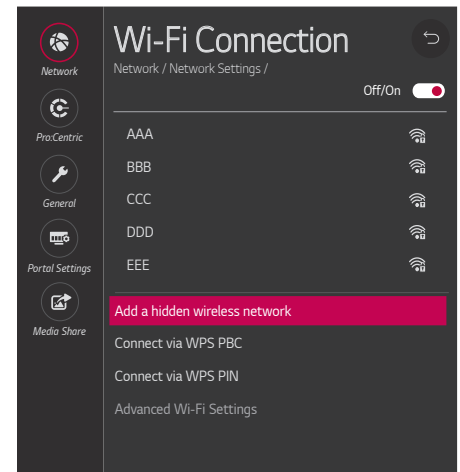

## LG Connect

LG Connect allows end users to use LG webOS Connect apps to pair the TV with a mobile device, which can then be used to access and control TV features (i.e., the device may be used as a mobile remote).

LG Connect requires that both the TV and the mobile device be on the same Wi-Fi network. See “Configuring a Wi-Fi Network Connection” above for information on configuring the wireless network connection. This menu enables you to turn LG Connect either on or off. It also allows you to delete all existing stored device pairings.

1. With the Network Menu on display, use the arrow keys on the Installer Remote to select **LG Connect**. Then, press **OK**.
2. Select/highlight the Off/On toggle button at the top right of the LG Connect Apps screen, and press **OK** on the Installer Remote to turn LG Connect on or off.
3. If you wish to delete all stored device pairings, turn on LG Connect as described in the previous step (if it is not on already), select/highlight the **Revoke Pairing** button (only accessible when LG Connect is turned on), and press **OK** on the Installer Remote. At the prompt for confirmation, either select **Yes** and press **OK** to delete the list of paired devices, or select **No** and press **OK** to return to the LG Connect screen without deleting stored pairings.
4. When you are finished, use the arrow keys on the Installer Remote to return to the IP Environment Menu, as necessary, or press **↵** to return to the Network Menu and/or exit the IP Environment Menu.

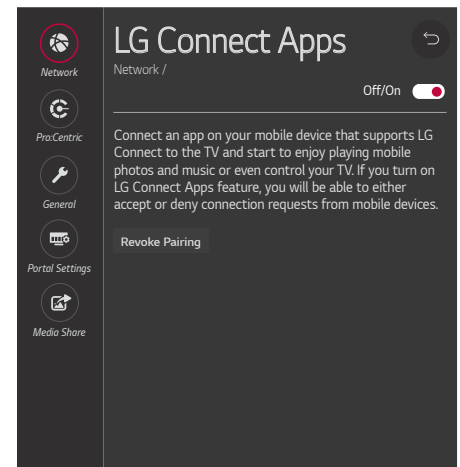

## IP Stream Control

If necessary, due to an audio and/or video stream delay, IP Stream Control options enable you to compensate for synchronization irregularities by allowing audio PTS and video PTS offset modifications. This menu also enables you to specify the IGMP version (2 or 3). Note that any modifications to these settings should be performed by qualified personnel only.

1. With the Network Menu on display, use the arrow keys on the Installer Remote to select **IP Stream Control**. Then, press **OK**.
2. In the IP Stream Control screen, use the Up/Down arrow keys on the Installer Remote to select/highlight the appropriate field and press **OK**.
  - To modify an offset value: use the Left/Right arrow keys to select the appropriate value for the selected field. Offset values represent offset time in milliseconds (ms) and can be adjusted from 0 ms to +500 ms in 10 ms increments.
  - To modify the IGMP version: use the Up/Down arrow keys to select the appropriate version number from the drop-down list of options, and then, press **OK**.
3. When you are finished, use the arrow keys on the Installer Remote to return to the IP Environment Menu, as necessary, or press **↵** to return to the Network Menu and/or exit the IP Environment Menu.

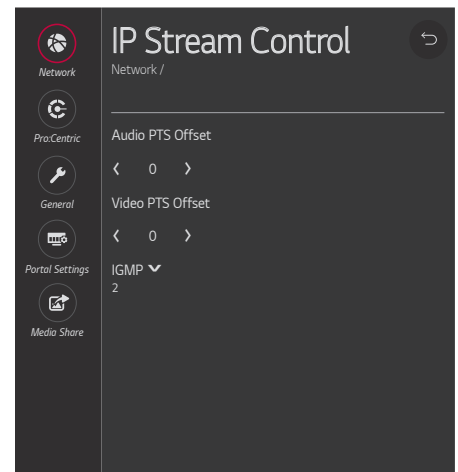

## Wake On LAN Setup

The Wake On LAN feature enables the TV to receive software updates and/or be powered ON upon receipt of Magic Packet data via the wired LAN. To facilitate use of this feature, note that the appropriate wired connection must be made. This menu option enables you to specify Wake On LAN parameters.

1. With the Network Menu on display, use the arrow keys on the Installer Remote to select **Wake On LAN**. Then, press **OK**.
2. In the Wake On LAN screen, use the Up/Down arrow keys on the Installer Remote to select/highlight the WOL (Magic Packet) field (if it is not already selected) and press **OK**. Then, use the arrow keys to select the desired setting—Disabled, Update, or Power On—from the drop-down list of options.
3. When you are finished, use the arrow keys on the Installer Remote to return to the IP Environment Menu, as necessary, or press **↵** to return to the Network Menu and/or exit the IP Environment Menu.

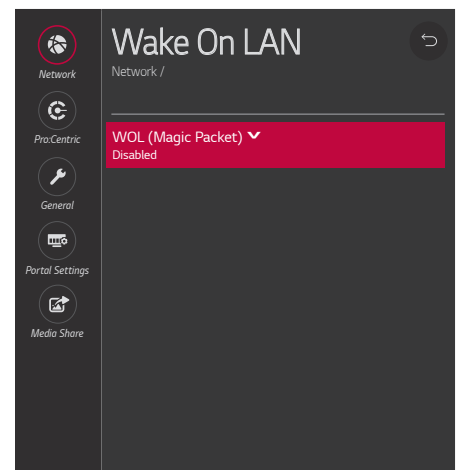

# IP Environment Setup (Cont.)

---

## Ping Test

The Ping Test option enables you to ping an IPv4 or IPv6 network address or URL.

1. With the Network Menu on display, use the arrow keys on the Installer Remote to select **Ping Test**. Then, press **OK**.
2. In the Enter the Network Address to Ping pop-up window at the bottom of the screen, use the arrow keys on the Installer Remote to select the desired Type option—IPv4 or IPv6 (i.e., IP Address) or URL.
3. To enter the IP address or URL data, select each data entry field and press **OK**. You can use the number keys on the Installer Remote to direct enter numeric values or use the arrow keys to select the appropriate alphanumeric values (as applicable) from the pop-up virtual keyboard displayed at the bottom of the screen. When you are done, select **Enter** from the virtual keyboard, and then press **OK** on the Installer Remote.
4. When you are ready, select **Begin Test**, and then press **OK** on the Installer Remote.

The network address will be pinged 10 times and then a summary of the ping statistics will be displayed, for example:

### Ping Test Result

Ping statistics for [xxx.xxx.xxx.xxx]

Packets : Sent = 10, Received = 10, Lost = 0 (0% loss)

Approximate round trip times in milliseconds

Minimum = 0.462 ms, Maximum = 5.43 ms, Average = 1.784 ms

5. Select **OK** in the pop-up window, and then press **OK** on the Installer Remote to close the pop-up window when you are finished.

## Pro:Centric Setup

Pro:Centric options enable you to configure the TV with the appropriate settings to connect to the Pro:Centric server—either a standard Pro:Centric server installed on-site or a Pro:Centric Cloud server. Use the Up/Down arrow keys on the Installer Remote to navigate between fields.

1. With the IP Environment Menu on display, use the arrow keys on the Installer Remote to select the **Pro:Centric** menu option. Then, press **OK**.

**Note:** By default, the Pro:Centric Menu initially shows RF configuration fields for a “Standard Pro:Centric Server” Server Type, i.e., a server installed on-site. When “IP” is selected in the Media Type field, Server Address, IP Type, IP Address, and Port Number fields appear on the screen, in place of the Data Channel field. When the Server Type is set to “LG Pro:Centric Cloud,” an Installation Code field is displayed on the screen.

(Continued on next page)

(Continued from previous page)

**Note:** If the Server Type or Media Type has already been set in the Advanced Settings / EZ-Manager Wizard, the specified value will be reflected in this field.

2. Select/highlight the **Server Type** field and press **OK** on the Installer Remote to display the drop-down list of options. Then, use the Up/Down arrow keys to select the applicable option:
  - If a Pro:Centric server is installed on-site, select **Standard Pro:Centric Server**.
  - If you will be using LG's Pro:Centric Cloud solution to configure TVs at the site, select **LG Pro:Centric Cloud**.
3. Refer to the appropriate subsection below—"Standard Pro:Centric Server Setup" or "Pro:Centric Cloud Server Setup" based on Server Type—to complete configuration of the TV's Pro:Centric settings to match those of the Pro:Centric server.
4. When you are finished, use the arrow keys on the Installer Remote to return to the IP Environment Menu, as necessary, or press **↵** to exit the IP Environment Menu.

## Standard Pro:Centric Server Setup

The following procedure describes how to complete the TV's Pro:Centric configuration for a "Standard Pro:Centric Server" Server Type, i.e., a server installed on-site. See example at right.

**Note:** While the Pro:Centric application itself is an additional feature (see step 3), the appropriate Pro:Centric server configuration must be completed to enable TV E-Z Installation (boot logo, configuration, and software) data downloads and, if configured, the Pro:Centric application download. Thus, this procedure begins with the step to select the Media Type.

1. Select/highlight the **Media Type** field and press **OK** on the Installer Remote to display the drop-down list of options. Then, use the Up/Down arrow keys to select either **RF** or **IP**, as applicable.
2. Refer to the appropriate subsection to configure the TV's Pro:Centric settings to match those of the Pro:Centric server.

### *RF Configuration*

For TVs in Pass-through Mode or FTG Mode via CPU, if the Data Channel is left at its default value (AUTO), the TV's Data Channel Auto Search feature will be enabled. See Installer Menu item 119 DATA CHANNEL description on page 73 for further information.

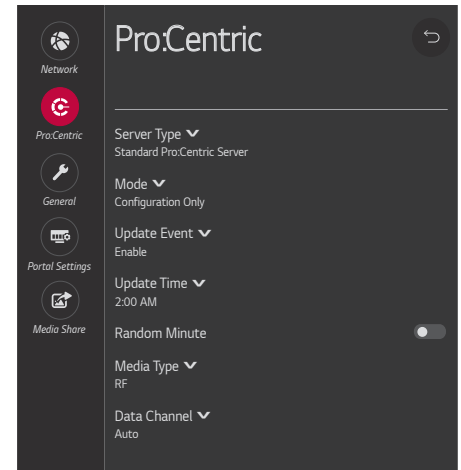

**Note:** Prior to CPU v4.45.90, Update Event is an On/Off toggle field, and Random Minute is not an option in this menu.

(Continued on next page)

# IP Environment Setup (Cont.)

---

(Continued from previous page)

- To change the Data Channel setting, select/highlight the **Data Channel** field and press **OK** on the Installer Remote. Then, use the Up/Down arrow keys to select either **MANUAL** or **AUTO** from the drop-down list of options.
- When the Data Channel field is set to “MANUAL,” a data entry field is available on the screen, and you can specify the RF channel number that will be used by the Pro:Centric server as its data channel. The Data Channel value can be set from 0 (disabled) to 135.\*

Use the arrow keys on the Installer Remote to select the Data Channel data entry field and press **OK**. You can then use the number keys on the Installer Remote to direct enter the Data Channel, or you can use the arrow keys to select the appropriate number(s) from the pop-up virtual keyboard displayed at the bottom of the screen. When you are done, select **Enter** from the virtual keyboard, and then press **OK** on the Installer Remote.

**Note:** If the Data Channel has already been set in the Installer Menu (item 119) or in the Advanced Settings / EZ-Manager Wizard or Hospital Setup Wizard, the specified channel will appear in the Data Channel data entry field. If you change the Data Channel in this menu, Installer Menu item 119 will now show the value you entered here.

## *IP Configuration*

**Note:** If the server IP address and port number or domain name have already been set in the Advanced Settings / EZ-Manager Wizard or Hospital Setup Wizard, the specified data will be reflected in the fields displayed.

**Note:** Setting the Media Type to “IP” automatically sets item 119 DATA CHANNEL in the Installer Menu to 253. You cannot alter this setting unless you revert Media Type to “RF.” Also, it is not possible to direct enter “253” in the Installer Menu.

- a) The Server Address field provides the option to specify the domain name of the Pro:Centric server instead of the server’s IP address. Select/highlight the **Server Address** field and press **OK** on the Installer Remote. Then, use the Up/Down arrow keys to select either **IP Address** or **Domain Name** from the drop-down list of options for defining the server.
- b) Depending on your selection in the previous step, either:
  - Select the appropriate IP type (either IPv4 or IPv6) in the IP Type field, and then enter the Pro:Centric server IP address in the IP Address field. The IP address must match the IPv4 or IPv6 (as applicable) address that is set in the Pro:Centric server.
  - Enter the Pro:Centric server domain name—up to 63 characters (no spaces allowed)—in the Domain Name field. Note that in order for the domain name to be resolved to an IP address, there must be a DNS entry for the domain name.

(Continued on next page)

\* PCS150R and later Pro:Centric servers do not support HRC or IRC cable channel frequencies.

(Continued from previous page)

For each data entry field: Use the arrow keys to select the field and press **OK**. Then, you can either use the number keys on the Installer Remote to direct enter data values, or you can use the arrow keys to select the appropriate number(s)/alphanumeric character(s) from the pop-up virtual keyboard displayed at the bottom of the screen. When you are done, select **Enter** from the virtual keyboard, and then press **OK** on the Installer Remote.

- c) Enter the Pro:Centric server port number in the Port Number field. The port number must match the port number that is set in the Pro:Centric server.
3. Select/highlight the **Mode** field and press **OK** on the Installer Remote to display the drop-down list of options. Then, use the Up/Down arrow keys to select the appropriate Pro:Centric Application Mode setting—**Configuration Only**, **GEM** (Java), or **HTML**. If the Pro:Centric Application Mode is set to “Configuration Only,” Pro:Centric application data will not be downloaded.

**Note:** If the mode has already been set in the Installer Menu (item 098 PRO:CENTRIC) or in the Advanced Settings / EZ-Manager Wizard or Hospital Setup Wizard, the specified mode will be reflected in this field. If you change the mode in this menu, Installer Menu item 098 will now reflect the value you selected here.

4. Select/specify the appropriate Update Event setting(s), as required. Based on Update Time settings, the Wake For Update feature wakes the TV once daily to check for, and if applicable, download updates from the Pro:Centric server. See Installer Menu item 121 UPDATE TIME HR description on page 73 for additional information on Wake For Update functionality.

- Select/highlight the **Update Event** field and press **OK** on the Installer Remote. Then, use the Up/Down arrow keys to select the appropriate Update Event setting—**Enable (Default)** or **Enable**. See Installer Menu item 121 description on page 73 as well as bullets below. Also, note that prior to CPU v4.45.90, Update Event is an On/Off toggle field.
- When Update Event is set to “Enable (Default),” the Update Time field is grayed out, and the update event is scheduled according to the Random Distribution of Update Time described on page 73.
- When Update Event is set to “Enable,” you can specify the Wake For Update time, as required. Select/highlight **Update Time** and press **OK** on the Installer Remote. Then, use the arrow keys to select the appropriate hour, minute, and meridiem values. Note that the Update Time set in this menu is based on a 12-hour clock. Ensure the meridiem (AM/PM) specification is set accordingly.

(Applicable only with CPU v4.45.90 or later) To invoke the “random” minute assignment on the TV, select/highlight the **Random Minute** field and press **OK** on the Installer Remote to toggle the setting on. In this case, the minute setting in the Update Time field will be disabled.



**Caution: Update Event should NEVER be set to “Prevent.” This setting is intended for factory use only.**



# IP Environment Setup (Cont.)

## Pro:Centric Cloud Server Setup

This section describes how to complete the TV's Pro:Centric configuration for an "LG Pro:Centric Cloud" Server Type (applicable only with CPU v4.41.00 or later and PTC v1.00.011 or later). See example at right.

**Note:** You will need the six-digit installation code for this property in order to set up the Pro:Centric Cloud (virtual) server configuration. The installation code is generated in the Pro:Centric Cloud portal. A user with an Administrator role for this property must provide/generate the code. The procedure below also assumes this property has already been added to the Pro:Centric Cloud portal. Refer to the **Pro:Centric Cloud Portal User Guide** for further information.

Select/highlight the **Installation Code** field and press **OK** on the Installer Remote. Then, either use the number keys on the Installer Remote to direct enter the installation code, or use the arrow keys to select the appropriate numbers from the pop-up virtual keyboard displayed at the bottom of the screen.

When you are done, select **Enter** from the virtual keyboard, and then press **OK** on the Installer Remote.

The TV will attempt to connect with the server. When the installation code is verified, you will see a "Server Found" message below the Installation Code field.

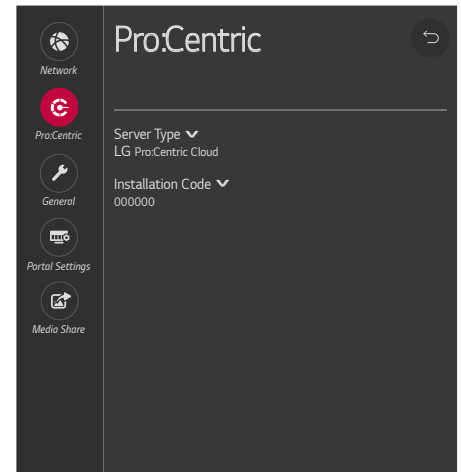

## General Options

The General Menu enables you to view and enable varied security settings for this TV. See examples on the following page, and refer to the appropriate subsection(s) below.

### Accessing the General Menu

With the IP Environment Menu on display, use the arrow keys on the Installer Remote to select the **General** menu option. Then, press **OK**.

### Security Options

1. With the General Menu on display, use the arrow keys on the Installer Remote to select/highlight **Security**. Then, press **OK**.
2. With the Security Menu on display, you have the options listed below. See also example at right.
  - To view security settings for TCP and UDP ports, use the arrow keys on the Installer Remote to select/highlight **Port Control**. Then, press **OK**.

Security settings for the TCP and UDP ports will be displayed in a new Port Control screen. Blocked ports (if any) are listed in the bottom half of the screen. This list is read-only.

(Continued on next page)

(Continued from previous page)

- To view TV information/status details, use the arrow keys on the Installer Remote to select/highlight **TV Information**. Then, press **OK**.

The TV information displayed includes the model, serial number, TV name, webOS version, total power on time, available internal storage, etc.

- To check the status of and/or run diagnosis on selected TV features, use the arrow keys on the Installer Remote to select/highlight **Check Items**. Then, press **OK**. With the Check Items Menu on display, use the arrow keys on the Installer Remote to select/highlight **Check the Status of TV**. Then, press **OK**.

Use the arrow keys on the remote to select/highlight the item you wish to check and press **OK**. Then, follow the instructions on the screen. This feature enables you to check the status of features such as Bluetooth, Wi-Fi, and/or MMR functionality.

- If you would like to set up password protection for the TV Manager, refer to the “TV Manager Password Protection” sub-section below.
  - The Software Update option in this menu enables you to update TV software via an NSU web server. Contact your LG service representative for further information. Permission is required for server access.
3. When you are ready to return to the Security Menu, press **↩** on the Installer Remote.
  4. When you are finished in the Security Menu, use the arrow keys on the Installer Remote to return to the IP Environment Menu, as necessary, or press **↩** to return to the General Menu or exit the IP Environment Menu.

## TV Manager Password Protection

This option enables you to set a four-digit password for the TV Manager, as an added layer of protection against undesired access. When this feature is enabled, a password prompt is displayed each time a user accesses the TV Manager.

1. With the General Menu on display, use the arrow keys on the Installer Remote to select/highlight **Security**. Then, press **OK**.
2. With the Security Menu on display, use the arrow keys on the Installer Remote to select/highlight **TV Manager Password Protection**. Then, press **OK**. See example on following page.

If this feature has never been accessed before, a Set Password prompt will be displayed at the bottom of the screen, along with a virtual keyboard.

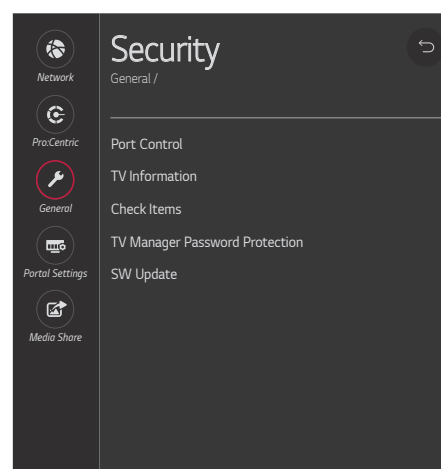
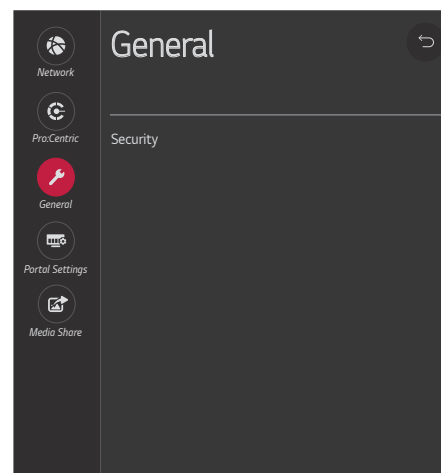

(Continued on next page)

# IP Environment Setup (Cont.)

(Continued from previous page)

3. If the Set Password prompt is displayed, you can either use the number keys on the Installer Remote to direct enter data values, or you can use the arrow keys to select the appropriate numbers from the virtual keyboard. When you are done, select **Enter** from the virtual keyboard, and then press **OK** on the Installer Remote.
4. If you would like to enable/disable password protection, select/highlight the **TV Manager Password Protection** field and press **OK** on the Installer Remote to toggle the setting as required.
5. If you need to reset the password at any time, select **Reset Password** and press **OK**.

An Enter Password prompt will be displayed at the bottom of the screen, along with a virtual keyboard. You can either use the number keys on the Installer Remote to direct enter data values, or you can use the arrow keys to select the appropriate numbers from the virtual keyboard. When you are done, select **Enter** from the virtual keyboard, and then press **OK** on the Installer Remote.

6. If you would like to return to the Security Menu, press **↵** on the Installer Remote.
7. When you are finished in the Security Menu, use the arrow keys on the Installer Remote to return to the IP Environment Menu, as necessary, or press **↵** to return to the General Menu or exit the IP Environment Menu.

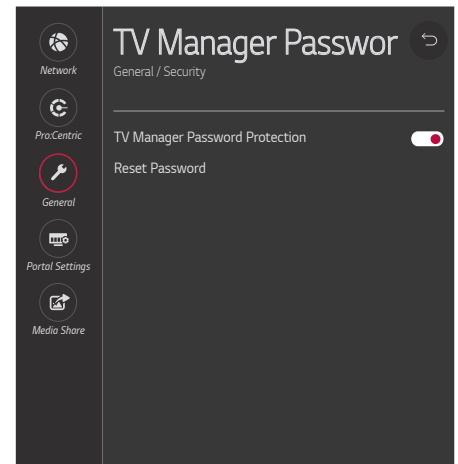

## Portal Settings

The Portal Settings Menu enables you to set up a customized local portal for this TV. It also allows you to select which of the pre-loaded application icons to display in the TV's Smart Launcher. Refer to the appropriate subsection below.

### Portal Options

Portal setup options in the Portal Menu are independent of the Pro:Centric portal. If you intend to load a Pro:Centric application on the TV(s) at the site, use the appropriate Pro:Centric Admin Client to configure the portal features.

1. With the IP Environment Menu on display, use the arrow keys on the Installer Remote to select the **Portal Settings** menu option. Then, press **OK**.
2. Select/highlight the **Portal Mode** field and press **OK** on the Installer Remote to display the drop-down list of options. Then, use the Up/Down arrow keys to select the applicable setting—Default Portal, Customizable Portal, or None.

(Continued on next page)

(Continued from previous page)

**Note:** If the Portal Mode has already been set in the Basic Settings Wizard, the specified value will be reflected in this field.

**Note:** The default value in this field is “Default Portal,” which enables the TV’s standard Smart Launcher. See also “Pre-loaded Applications” below.

3. Select/highlight the **Auto Start** field and press **OK** on the Installer Remote to display the drop-down list of options. Then, use the Up/Down arrow keys to select the applicable setting—Off or Portal Mode. This specifies whether the portal should be displayed each time the TV is turned ON (as opposed to only being displayed when the end user presses PORTAL on the remote).

**Note:** If the Auto Start status has already been set in the Basic Settings Wizard, the specified value will be reflected in this field.

4. Use the Website Shortcut, Input Shortcut, Hotel (Hospital) Directory, Portal Editor, and Portal Manager options to create and/or modify the customized portal content, as applicable. You may add up to five website shortcuts and up to seven hospital directories. Follow on-screen instructions to complete the setup.
5. When you are finished in the Portal Settings Menu, use the arrow keys on the Installer Remote to return to the IP Environment Menu, as necessary, or press **↵** to exit the IP Environment Menu.

**Note:** For further information on the portal settings and options, contact your LG service representative.

## Pre-loaded Applications

This option allows you to select which of the pre-loaded application icons to install/make available in the TV’s Smart Launcher, which appears along the bottom of the screen in the TV’s default Portal Mode.

When the Pro:Centric application is disabled, the Smart Launcher is available to end users via the PORTAL key on the remote control. Depending on the remote control being used, the Smart Launcher may also be available to end users via a SMART key.

1. With the IP Environment Menu on display, use the arrow keys on the Installer Remote to select the **Portal Settings** menu option. Then, press **OK**.
2. Make sure the Portal Mode is set to “Default Portal.” If necessary, select/highlight the **Portal Mode** field and press **OK** on the Installer Remote to display the drop-down list of options. Then, use the Up/Down arrow keys to select **Default Portal**.

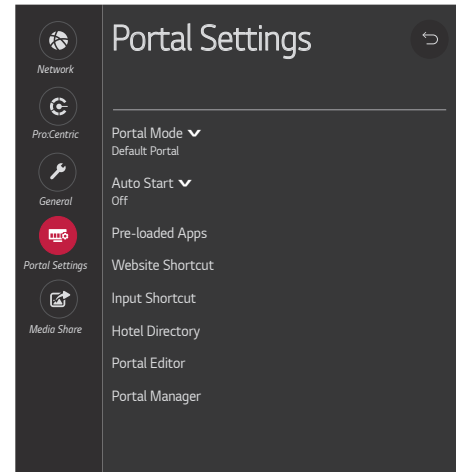

(Continued on next page)

## IP Environment Setup (Cont.)

---

(Continued from previous page)

3. Use the arrow keys on the Installer Remote to select **Pre-loaded Apps**. Then, press **OK**.

Application options will be displayed in a new Pre-loaded Apps screen. An App List on the left side of the screen shows the applications that are available, while an Installed App List on the right side of the screen shows the applications that have been installed.

4. You can either install or remove applications on the TV as required. Use the arrow keys on the Installer Remote to make selections.

- To install apps: Highlight each desired application in the App List, and press **OK** on the Installer Remote. A checkmark indicates that an app is selected.

When you are ready to continue, select/highlight the **Install** button below the App List, and then press **OK** on the Installer Remote. Installation progress will be displayed in a pop-up banner. When the process is complete, press **OK** on the Installer Remote to return to the Pre-loaded Apps screen.

- To remove apps: Highlight each desired application in the Installed App List, and press **OK** on the Installer Remote. A checkmark indicates that an app is selected.

When you are ready to continue, select/highlight the **Delete** button below the Installed App List, and then press **OK** on the Installer Remote. Removal progress will be displayed in a pop-up banner. When the process is complete, press **OK** on the Installer Remote to return to the Pre-loaded Apps screen.

**Note:** Though not included in the App List, Screen Share and SoftAP (as Wi-Fi Service) applications are available in the Smart Launcher once they are enabled in the Media Share Menu. See “Media Share Setup” below.

**Note:** Make sure to select/install any application(s) that may be used in conjunction with the DIAL feature, if applicable.

5. When you are ready to return to the Portal Settings Menu, use the arrow keys on the Installer Remote to select/highlight the **✕** button, and then press **OK**.
6. When you are finished in the Portal Settings Menu, use the arrow keys on the Installer Remote to return to the IP Environment Menu, as necessary, or press **↵** to exit the IP Environment Menu.

**Note:** While pre-loaded application selections are clonable, it is not possible to edit pre-loaded application selections in the Cloud Configuration Tool. Thus, if a TV has already been configured for FTG Mode via CPU and you would like to add or remove applications, you will need to import a new “.tlx” file with the appropriate model profile. That is, you will need to use a Master TV of the same model to create and export a “.tlx” file with the desired pre-loaded application selections (along with any other applicable Installer Menu settings), which can be transferred (imported) to the Target TV.

## Media Share Setup

The Media Share Menu allows you to enable the following Media Share features on this TV:

- LG Smart Share®: Allows end users to use the TV to access and view media files (photos, videos, music, etc.) shared by DLNA Certified® devices connected to the same LAN as the TV.
- Screen Share: Enables screen sharing with a Miracast® or Wireless Display (WiDi) capable device (e.g., a laptop with Intel® hardware).
- Media Renderer: Enables the TV to act as a media renderer to receive content from DLNA Certified devices on the same network.
- DIAL (Discovery and Launch): Allows end users to play selected application media on the TV from a device with DIAL capability. The device may be used to cast any application for which a TV-compatible application has been created/selected for inclusion in the Pre-loaded Apps Menu (e.g., YouTube—see also “Pre-loaded Applications” above). Note that the device must be connected to the same network as the TV.
- SoftAP: Enables the TV to function as a wireless access point for up to 10 devices. Note that a wired network connection **MUST** be established in order for end users to use SoftAP.
- Beacon: Enables the TV to function as either an iBeacon™ or Eddystone™ beacon device for Bluetooth broadcasting.

**Note:** See also Reference section, “Using Media Share Features,” for additional information on these features.

1. With the IP Environment Menu on display, use the arrow keys on the Installer Remote to select the **Media Share** menu option. Then, press **OK**.
2. Smart Share, Media Renderer, and DIAL features may be enabled or disabled as follows: Use the Up/Down arrow keys on the Installer Remote to select/highlight the desired feature, and then press **OK** on the Installer Remote to toggle the setting as required.
3. If you would like to enable Screen Share:
  - Select/highlight **Screen Share**, and then press **OK** to toggle the setting so that Screen Share is on.
  - Then, use the Up/Down arrow keys to select the desired option—**Enable**, **Enable (PIN)**, or **Disable**—from the drop-down list of options.

**Note:** If you select “Enable (PIN),” users will be prompted to enter a randomly generated PIN when connecting a device to the TV.

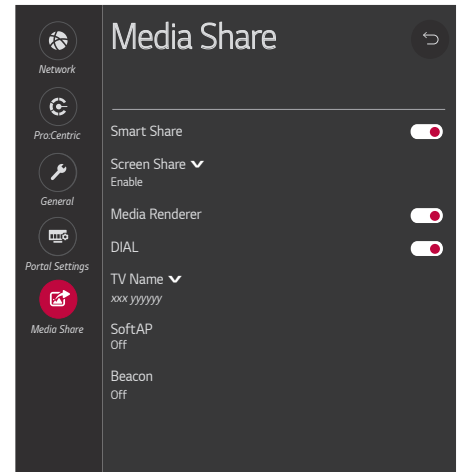

(Continued on next page)

## IP Environment Setup (Cont.)

(Continued from previous page)

4. If you would like to enable SoftAP, complete the SoftAP access configuration as follows:

- Select/highlight **SoftAP** and press **OK** on the Installer Remote.
- Select/highlight the Off/On toggle button at the top right of the SoftAP screen (see example at right), and press **OK** on the Installer Remote to turn on SoftAP.
- To enable use of a randomly generated security key for SoftAP access, select the **Use Default** field, and press **OK** on the Installer Remote to toggle the setting so that the default security key is enabled (the Security Key field will subsequently be grayed out and the random security key will be displayed).
- To specify your own security key for SoftAP access, toggle the Use Default field so that the default security key is disabled. Then, select the **Security Key** field and press **OK**. In the data entry field, you can use the number keys on the Installer Remote to direct enter a numeric security key, or you can use the arrow keys to select the appropriate alphanumeric characters—at least eight, but no more than 64—from the pop-up virtual keyboard displayed at the bottom of the screen.

Note that the security key may not contain any special characters (:, /, \, @, etc.). When you are done, select **Enter** from the virtual keyboard, and then press **OK** on the Installer Remote.

- Select the appropriate values in the Wi-Fi Signal Strength and Wi-Fi Channel fields, as required.
5. If you would like to enable Beacon, complete the Beacon access configuration as follows:

**Note:** For iBeacon, you will need to enter the beacon's UUID, Major, and Minor parameters. For Eddystone, you will need to enter the beacon's URL parameters. You should have the pertinent information available before you continue.

- Select/highlight **Beacon** and press **OK** on the Installer Remote.
- Select/highlight the Off/On toggle button at the top right of the Beacon screen (see example on following page), and press **OK** on the Installer Remote to turn on Beacon.
- Select/highlight the **Type** field and press **OK** on the Installer Remote to display the drop-down list of options. Then, use the Up/Down arrow keys to select the applicable Beacon type—either iBeacon or Eddystone.

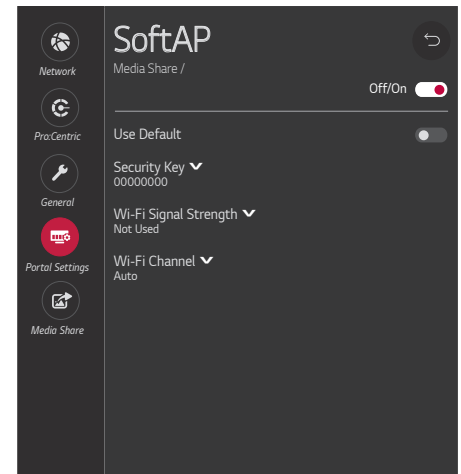

(Continued on next page)



(Continued from previous page)

- Select each data entry field in turn, and provide the appropriate information. In the data entry fields, you can use the number keys on the Installer Remote to direct enter numbers, or you can use the arrow keys to select the appropriate alphanumeric characters from the pop-up virtual keyboard displayed at the bottom of the screen. When you are done, select **Enter** from the virtual keyboard, and then press **OK** on the Installer Remote.
  - When you have entered all the beacon identification data, select the **OK** button at the bottom of the menu, and then press **OK** on the Installer Remote.
  - At the prompt for broadcast confirmation, select either **Yes** to broadcast the Beacon or **No** if you do not want to broadcast the Beacon.
6. If desired, you can specify a name for this TV so that it is easy to identify and differentiate from other TVs for which sharing has been/will be enabled.

**Note:** By default, the TV name is “[LG] webOS TV” + the TV’s model name. However, if a room number is specified in the Advanced Settings / EZ-Manager Wizard or in the General Menu / Room Info screen, the TV name is changed to the room number.

To edit the TV name, use the Up/Down arrow keys to select the **TV Name** field, and then press **OK**. You can then use the number keys on the Installer Remote to direct enter a numeric TV name, or you can use the arrow keys to select the appropriate alphanumeric character(s) from the pop-up virtual keyboard at the bottom of the screen. When you are done, select **Enter** from the virtual keyboard, and then press **OK** on the Installer Remote.

7. When you are finished, use the arrow keys on the Installer Remote to return to the IP Environment Menu, as necessary, or press ↵ to exit the IP Environment Menu.

**Note:** After all Media Share feature settings are done, reboot the TV to complete each setup. If you intend to modify additional menu settings, unless prompted otherwise, you may wait until all changes are complete before you reboot the TV.

**Note:** While Smart Share, Screen Share, Media Renderer, DIAL, and Beacon settings are clonable, SoftAP settings, as well as the TV name cannot be cloned.

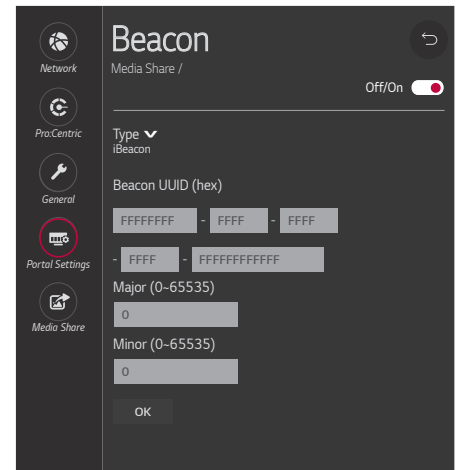

# Reference: Updating TV/PTC Software using a USB Memory Device

---

This section describes how to update TV (CPU) and/or PTC software using the TV Manager “Update TV Software” and/or “Update PTC Software” option(s), respectively, though you may also use the Ez Download utility to update software, if desired. See “Ez Download Utility” on pages 56 to 60 for further information.

## Before You Begin

- Software update files must be stored in a folder named “LG\_DTV” in the root directory of the USB memory device.
- Ensure the USB device has been formatted with FAT format.

## Update the TV/PTC Software

**Note:** You can check the TV/PTC software versions by accessing the Installer Menu with the Installer Remote. See “Accessing the Installer Menu” on page 61 for further information. PTC and CPU versions are displayed in the Installer Menu footer.

**Note for TV CPU Software Update only:** If the TV detects a software file on the USB device, it will automatically display an Update TV Software screen, and if the file contains a later version of software than is currently running on the TV, you can start the software update from this screen (select **Update** and press **OK**). Otherwise, you can exit the screen (select **Cancel** and press **OK**), and access the TV Manager as described below.

1. Turn ON the TV, and then insert the USB memory device into either of the USB ports on the TV.
2. Press **MENU** on the Installer Remote to display the TV setup menus (TV is in Pass-through Mode) or the Function Menu (TV is not in Pass-through Mode).
3. (TV in Pass-through Mode only) From the Quick Settings Menu displayed at the left of the screen, select the **All Settings**  menu icon and press **OK** to access the advanced TV setup menus.
4. Use the arrow navigation keys to select/highlight either the **General** menu icon from the TV setup menus or the **Safety** menu icon from the Function Menu. Then, press the number “7” key a total of seven times to access the TV Manager (see example on following page).

**Note:** If a password prompt is displayed (i.e., TV Manager Password Protection is enabled in the IP Environment / General Menu), key in the TV Manager password and press **OK**.

**Note:** Ez Download is always selected by default when you initially access the TV Manager. Also note that Diagnostics is for service use only.

5. If more than one USB memory device is currently connected to the TV, be sure to select the USB device that contains the applicable software file. If necessary, use the arrow keys on the Installer Remote to select/highlight the **USB Device** button in the top right corner of the screen and press **OK**. Then, use the Up/Down arrow keys to select the appropriate USB device from the pop-up list of USB devices.

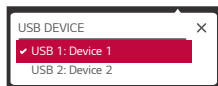

(Continued on next page)

# Reference: Updating TV/PTC Software using a USB Memory Device (Cont.)

(Continued from previous page)

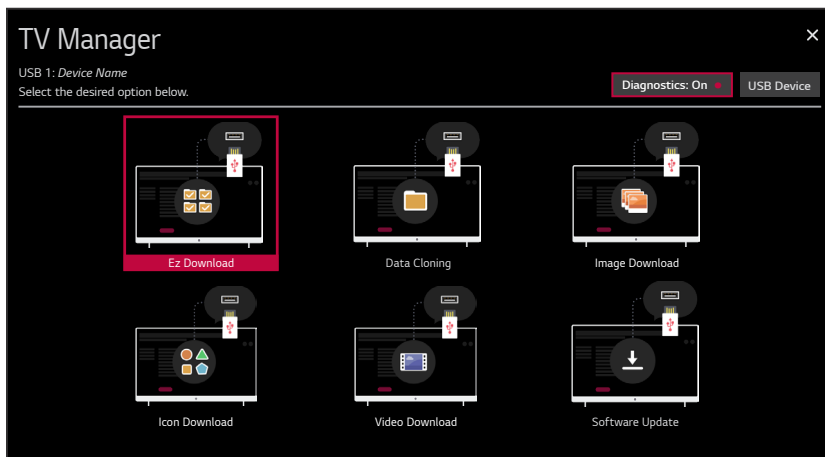

6. Use the arrow keys to select **Software Update**, and then press **OK**.
7. Use the Up/Down arrow keys to select **Update TV Software** or **Update PTC Software**, as applicable, and press **OK**.

Depending on your selection, a list of either TV or PTC software files stored in the LG\_DTV folder on the USB memory device will be displayed on the screen. Above the listing of files, you can also see the current version of TV or PTC software. The following example illustrates an Update TV Software screen.

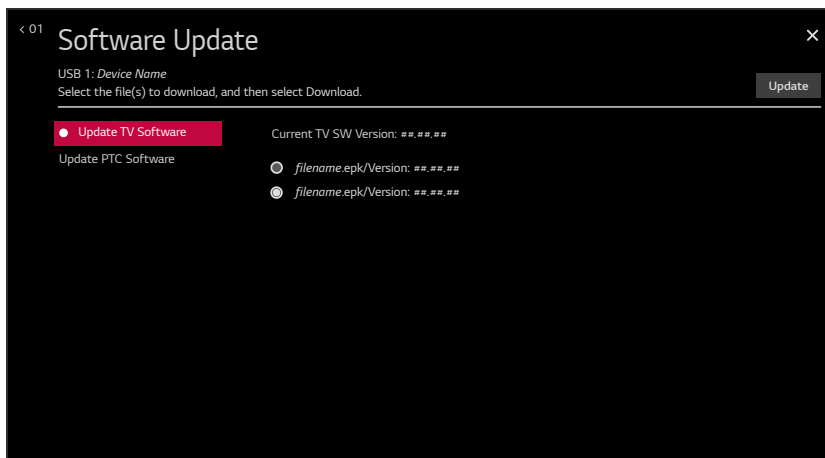

8. Use the arrow keys to select/highlight the update file to download, and then press **OK**.
9. When you are ready to download the update, select **Update** on the screen, and then press **OK** on the Installer Remote.

Software update progress will be displayed on the screen. Do NOT remove the USB device until the software update is complete. When the software update is complete, a "Software Update is completed" pop-up message will briefly be displayed on the screen, and then, the TV will reboot.

# Reference: Downloading Images or Icons using a USB Memory Device

---

This section describes how to download the image types listed below using the TV Manager “Image Download” or “Icon Download” options, though you may also use the Ez Download utility to download the image(s), if desired. See “Ez Download Utility” on pages 56 to 60 for further information.

- A boot logo image, also known as a “splash screen,” is briefly displayed when the TV is turned ON from its standby (OFF) state.  
**Note:** When Installer Menu item 002 AC ON is set to 2, 3, 18, or 19 for Instant ON, a boot logo image is not displayed.
- Background images are intended for use with audio-only channels and applications, such as the Bluetooth Sound Sync feature or the Clock application, that by default have static backgrounds. End users may choose to display a slideshow on the screen while audio is playing. Up to 12 images may be selected.
- Hotel (Hospital) Directory images are intended for use with a local customized portal. Up to 12 images may be selected for up to six hospital directories.
- The Hotel (Hospital) Icon on Portal icon image is used for local customized portal branding. One icon image may be selected.
- Website Shortcuts are icon images. One icon image may be selected for up to five website directories.

## Boot Logo Image File Guidelines

- File formats supported: Baseline or progressive JPEG, JPG, or 24-bit (RGB 8x8x8) BMP.
- A JPEG or JPG image should be no larger than 6 MB.
- A BMP image should be no larger than 5.93 MB.
- The maximum resolution allowed for the image is 1920 x 1080 pixels.
- Avoid using special characters, such as ?, &, @, etc., in the image filename.

## Background and Hotel (Hospital) Directory Image File Guidelines

- File formats supported: Baseline or progressive JPEG, JPG, or PNG.
- Up to 12 image files (no more than 10 MB total) may be selected for background images and/or for hospital directories.
- The maximum resolution allowed for these images is 3840 x 2160 pixels.
- Avoid using special characters, such as ?, &, @, etc., in image filenames.

## Icon Image File Guidelines

- File formats supported: Baseline or progressive JPEG, JPG, or PNG.
- An icon image should be no larger than 10 MB.
- The maximum resolution allowed for these images is 3840 x 2160 pixels.
- Avoid using special characters, such as ?, &, @, etc., in image filenames.

# Reference: Downloading Images or Icons using a USB Memory Device (Cont.)

## Before You Begin

- The image file(s) must be stored in a folder named “LG\_DTV” in the root directory of the USB memory device.
- Ensure the USB device has been formatted with FAT format.

## Download the Image(s)

1. Turn ON the TV, and then insert the USB memory device into either of the USB ports on the TV.
2. Press **MENU** on the Installer Remote to display the TV setup menus (TV is in Pass-through Mode) or the Function Menu (TV is not in Pass-through Mode).
3. (TV in Pass-through Mode only) From the Quick Settings Menu displayed at the left of the screen, select the **All Settings**  menu icon and press **OK** to access the advanced TV setup menus.
4. Use the arrow navigation keys to select/highlight either the **General** menu icon from the TV setup menus or the **Safety** menu icon from the Function Menu. Then, press the number “7” key a total of seven times to access the TV Manager.

**Note:** If a password prompt is displayed (i.e., TV Manager Password Protection is enabled in the IP Environment / General Menu), key in the TV Manager password and press **OK**.

**Note:** Ez Download is always selected by default when you initially access the TV Manager. Also note that Diagnostics is for service use only.

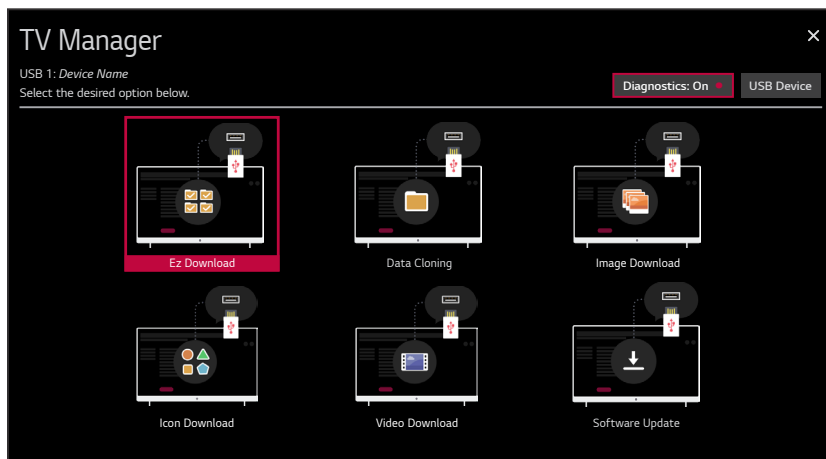

5. If more than one USB memory device is currently connected to the TV, be sure to select the USB device that contains the applicable image file(s). If necessary, use the arrow keys on the Installer Remote to select/highlight the **USB Device** button in the top right corner of the screen and press **OK**. Then, use the Up/Down arrow keys to select the appropriate USB device from the pop-up list of USB devices.



(Continued on next page)

## Reference: Downloading Images or Icons using a USB Memory Device (Cont.)

(Continued from previous page)

- Use the arrow keys to select **Image Download** or **Icon Download**, as applicable, and then press **OK**.

Depending on your selection in the previous step, either the Image Download or Icon Download screen will be displayed. The following example illustrates an Image Download screen.

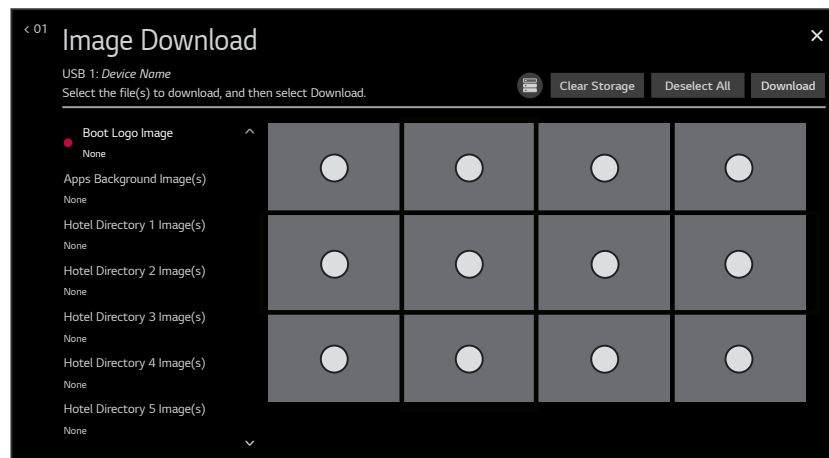

**Note:** You can select the  (Storage) button at the top of the screen to check the amount of storage available for and currently in use by media (image, icon, and video) files. Storage data will be displayed in a pop-up window. When you are finished, select **OK** to close the pop-up window. If you would like to clear all of the image or icon (depending on your selection in step 6) files currently in storage, select the **Clear Storage** button. Then, in the confirmation pop-up window, select **Yes** to clear the files, or select **No** to return to the Image Download or Icon Download screen, as applicable, without clearing the files.

- Use the Up/Down arrow keys to select the appropriate option from the list of file types at the left of the screen, and then press **OK**.
- In the image area at the right of the screen, use the arrow keys to select/highlight the image file(s) to download. Press **OK** to select a file (a checkmark  identifies a selected file). See also image guidelines at the beginning of this section.
- When you are ready to download the image file(s), select **Download** on the screen, and then press **OK** on the Installer Remote.

Download progress will be displayed on the screen. Do NOT remove the USB device until the image download(s) is/are complete. When the download process is complete, an “Image Download is completed” or “Icon Download is completed” message will be displayed on the screen (in accordance with your selection in step 6), and a “Done” button will be displayed/activated at the top right of the screen.

- Check the download status—at the left of the screen—for each image to make sure the download was successful, and then press **OK** on the Installer Remote to select **Done**.

When you select “Done,” the Image Download or Icon Download screen (depending on your selection in step 6) will be redisplayed, and you can download additional images and/or perform other TV Manager functions, as required.

# Reference: Downloading a Hotel (Hospital) Video using a USB Memory Device

This section describes how to download a hospital video using the TV Manager “Video Download” option, though you may also use the Ez Download utility to download the video, if desired. See “Ez Download Utility” on pages 56 to 60 for further information.

One hospital video may be selected for a local customized portal.

## Video File Guidelines

- File formats supported: DIVX, AVI, MKV, MP4, 3GP, 3G2, TS, TP, TRP, MPG, MPEG, VOB, VRO, ASF, WMV, MOV, DAT, F4V, FLV, TTS, ASX, M4V, K3G, M2TS, MPE, MTS, WEBM, LGE, LG2, LGV, MZ.
- The video size is only restricted by the TV’s storage capacity. You be will able to check the amount of space available from the Video Download screen, as described in the procedure below.
- Avoid using special characters, such as ?, &, @, etc., in the video filename.

## Before You Begin

- The video file must be stored in a folder named “LG\_DTV” in the root directory of the USB memory device.
- Ensure the USB device has been formatted with FAT format.

## Download the Video

1. Turn ON the TV, and then insert the USB memory device into either of the USB ports on the TV.
2. Press **MENU** on the Installer Remote to display the TV setup menus (TV is in Pass-through Mode) or the Function Menu (TV is not in Pass-through Mode).
3. (TV in Pass-through Mode only) From the Quick Settings Menu displayed at the left of the screen, select the **All Settings**  menu icon and press **OK** to access the advanced TV setup menus.
4. Use the arrow navigation keys to select/highlight either the **General** menu icon from the TV setup menus or the **Safety** menu icon from the Function Menu. Then, press the number “7” key a total of seven times to access the TV Manager (see example on following page).

**Note:** If a password prompt is displayed (i.e., TV Manager Password Protection is enabled in the IP Environment / General Menu), key in the TV Manager password and press **OK**.

**Note:** Ez Download is always selected by default when you initially access the TV Manager. Also note that Diagnostics is for service use only.

5. If more than one USB memory device is currently connected to the TV, be sure to select the USB device that contains the applicable video file. If necessary, use the arrow keys on the Installer Remote to select/highlight the **USB Device** button in the top right corner of the screen and press **OK**. Then, use the Up/Down arrow keys to select the appropriate USB device from the pop-up list of USB devices.



(Continued on next page)



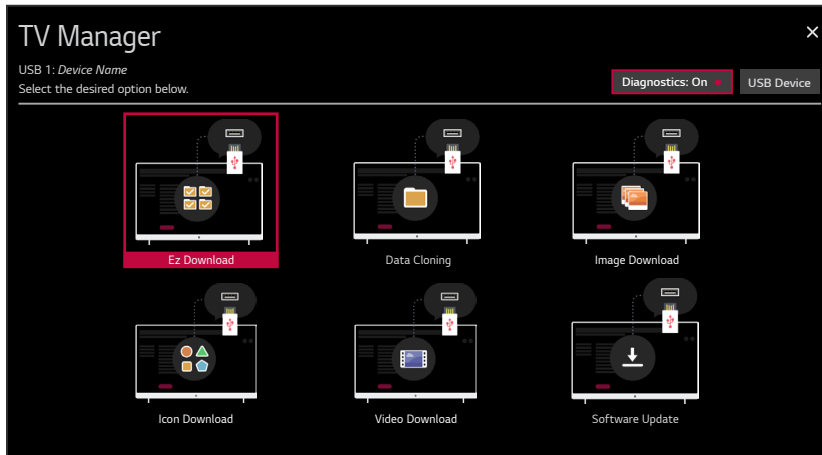

# Reference: Downloading a Hotel (Hospital) Video using a USB Memory Device (Cont.)

(Continued from previous page)

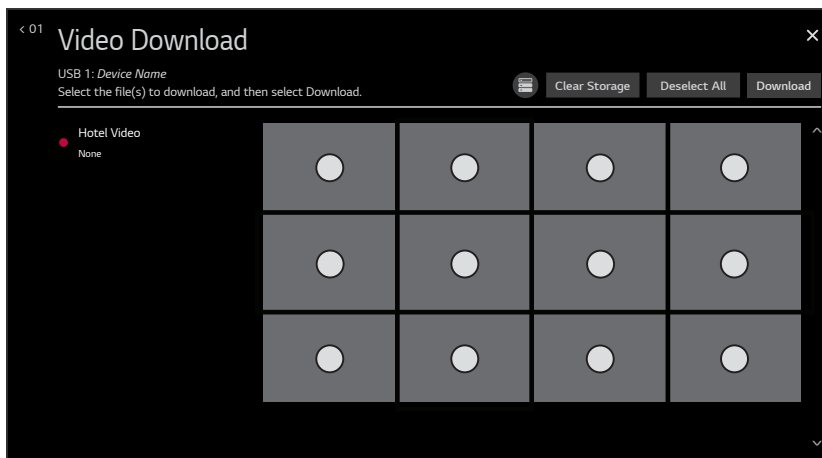

6. Use the arrow keys to select **Video Download**, and then press **OK**. The Video Download screen will be displayed.



**Note:** You can select the  (Storage) button at the top of the screen to check the amount of storage available for and currently in use by media (image, icon, and video) files. Storage data will be displayed in a pop-up window. When you are finished, select **OK** to close the pop-up window. If you would like to clear the video file currently in storage, select the **Clear Storage** button. Then, in the confirmation pop-up window, select **Yes** to clear the video file, or select **No** to return to the Video Download screen without clearing the video file.

7. In the thumbnail area at the right of the screen, use the arrow keys to select/highlight the video file to download. Press **OK** to select a file (a checkmark  identifies a selected file). See also video guidelines at the beginning of this section.

(Continued on next page)

## Reference: Downloading a Hotel (Hospital) Video using a USB Memory Device (Cont.)

---

(Continued from previous page)

8. When you are ready to download the video file, select **Download** on the screen, and then press **OK** on the Installer Remote.

Download progress will be displayed on the screen. Do NOT remove the USB device until the video download is complete. When the download process is complete, a "Video Download is completed" message will be displayed on the screen, and a "Done" button will be displayed/activated at the top right of the screen.

9. Check the download status—at the left of the screen—for the video to make sure the download was successful, and then press **OK** on the Installer Remote to select **Done**.

When you select "Done," the Video Download screen will be redisplayed, and you can perform other TV Manager functions, as required.

# Reference: Downloading a Pro:Idiom Media Key using a USB Memory Device

System providers may now define and apply their own Pro:Idiom Media Key (.pim) file to TVs at an installation site. This section describes how to download the Pro:Idiom Mobile Key file using the TV Manager Ez Download utility. Contact your LG service representative for further information on this feature.

## Before You Begin

- Obtain the proper Pro:Idiom Media Key (.pim) file from the system provider. Avoid using special characters, such as ?, &, @, etc., in the filename.
- The Pro:Idiom Media Key file must be stored in a folder named “LG\_DTV” in the root directory of the USB memory device.
- Ensure the USB device has been formatted with FAT format.

## Download the Pro:Idiom Media Key File

**⚠ Caution: If you restore the TV to a factory default condition, the default Pro:Idiom Media key will also be restored.**

1. Turn ON the TV, and then insert the USB memory device into either of the USB ports on the TV.
2. Access the Ez Download utility (see “Ez Download Utility” on pages 56 to 60 for further information).
3. With the Ez Download screen on display, use the Up/Down arrow keys to select **Download Pro:Idiom M Key**, and then press **OK**.

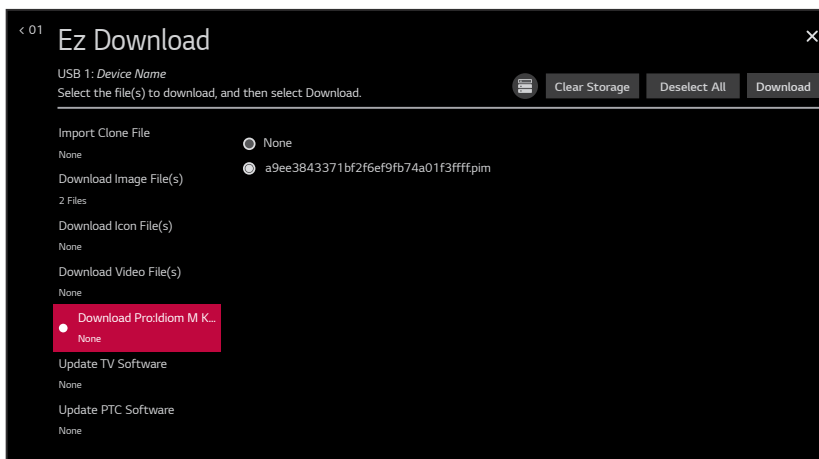

4. Use the arrow keys to select/highlight the Pro:Idiom Media Key file to download.
5. When you are ready to download the file, select **Download** on the screen, and then press **OK** on the Installer Remote.

Download progress will be displayed on the screen. Do NOT remove the USB device until the download is complete. When the Ez Download process is complete, an overview of the results will briefly be displayed and then, the TV will reboot.

6. Remove the USB memory device, and verify that the appropriate Pro:Idiom key is resident on the TV.

## Reference: Power Consumption Settings

The following tables assume that Installer Menu item 099 BACK LIGHTING is set as shown below (default value is 255).

Item 099 Back Lighting (Static)	55US772M		65US772M	
	Power Consumption (Watts)	Percent Savings	Power Consumption (Watts)	Percent Savings
100	108.5	0%	131.2	0%
90	99.8	8%	122.0	7%
80	92.2	15%	110.2	16%
70	83.5	23%	101.0	23%
60	76.0	30%	90.5	31%
50	68.4	37%	81.3	38%
40	59.7	45%	70.8	46%
30	52.1	52%	61.7	53%
20	43.4	60%	51.2	61%
10	36.9	66%	42.0	68%
1	28.2	74%	31.5	76%

Item 099 Back Lighting (Dynamic)	55US772M		65US772M	
	Power Consumption (Watts)	Percent Savings	Power Consumption (Watts)	Percent Savings
200	107.9	0%	129.0	0%
190	99.3	8%	118.7	8%
180	91.7	15%	109.7	15%
170	83.1	23%	99.3	23%
160	75.5	30%	89.0	31%
150	68.0	37%	80.0	38%
140	60.4	44%	69.7	46%
130	51.8	52%	60.6	53%
120	44.2	59%	50.3	61%
110	36.7	66%	41.3	68%
101	28.1	74%	31.0	76%

Note: Values are results of controlled experiments under laboratory conditions.

# Reference: TV Aux Input Configuration

DIRECT ACCESS Tuning *		TV		ENABLE					MPI DATA				Installer Menu Item 046 START AUX SRCE (Start Aux Source) Value
				Installer Menu			MPI DATA STATUS TYPE 0x41 SOURCES ENABLED (R/W)	DATA STATUS TYPE 0xD2 CURRENT AV SOURCE (R)	DATA STATUS TYPE 0x0D AUX SOURCE (R)				
Installer Menu Item 029 REMAP AUX INPS = 0	Installer Menu Item 029 REMAP AUX INPS = 1	Aux Input	Input Mode	Item	Function	Value	Enable Bit	Label	Value	Value	Description		
132-0	92-0	HDMI 2	DTV	91	HDMI2 ENABLE	1	2	S-Video Rear	2	0	VIDEO	5	
			PC			2				2	COMPUTER		
133-0	93-0	HDMI 1	DTV	35	HDMI1 ENABLE	1	3	Front Computer	3	0	VIDEO	3	
			PC			2				2	COMPUTER		

\* Use Installer Remote to enter channel number indicated based on REMAP AUX INPS Installer Menu setting.

Note: To add Aux inputs to an FTG Channel Map, use analog channel numbers in the 130 range, per table above, as the physical RF channel.

## Reference: *b*-LAN Setup & Overview

The *b*-LAN module is internal to the TV. It allows hospital/institution head end equipment with *b*-LAN technology to communicate, via the institution's RF distribution system, with the TV for configuration and control.

Installer Menu item 118 POWER SAVINGS controls the power circuitry for both the embedded *b*-LAN module and the GAME CONTROL/MPI port. The default value is 3—the *b*-LAN module is only powered when the TV is turned ON. See chart below.

POWER SAVINGS	TV OFF	TV ON
	<i>b</i> -LAN & GAME CONTROL/MPI Port Power	<i>b</i> -LAN & GAME CONTROL/MPI Port Power
1	On	On
3 (default)	Off	On

A *b*-LAN enabled head end device, such as an LG FMA-LG102, broadcasts over the RF distribution system to communicate to multiple TVs. When the TV is first installed, it must be turned ON in order for its embedded *b*-LAN module to receive communication from the head end device. At this point, if it is desired for the *b*-LAN module to always be powered, including while the TV is turned OFF, set Installer Menu item 118 POWER SAVINGS to 1.

Also, if MPI communication is required for external MPI control, set Installer Menu item 118 POWER SAVINGS to 1 so that the GAME CONTROL/MPI port circuitry is always powered.



**Caution: POWER SAVINGS should NEVER be set to 7. This setting is intended for factory use only.**

# Reference: FTG Mode via EBL (Local Configuration)

**Note:** FTG Device Configuration Application version 5.5.8 is the latest and final release of this software. There will be no future releases. However, the application may still be used for FTG Mode via EBL configuration, as described below.

**Note:** If you are using an FMA head end device for remote management and you wish to include FTG Installer Menu settings for this model in an FMA Configuration (.fma) file, you will need to “Read” FTG Installer Menu settings from a Master US772M TV that is already configured for FTG Mode via EBL. That is, you will need to perform all steps of the procedure below before you can add an FTG Installer Menu profile for this model to the FMA Configuration List in the FMA Configuration Utility. See the *Free-To-Guest (FTG) Device Configuration Application User Guide* for further information on the FMA Configuration Utility.

The following steps outline local FTG configuration of individual TV EBLs using a direct PC-to-TV (EBL) connection. Refer to the *Free-To-Guest (FTG) Device Configuration Application User Guide* for further information. FTG Device Configuration Application software is available online at: [www.lg.com/us/business/display-solutions/ftg](http://www.lg.com/us/business/display-solutions/ftg).

**Note:** If the TV CPU is already in FTG Mode, you cannot use this procedure to make changes to the FTG Channel Map and FTG Installer Menu settings. Refer to FTG Mode information on pages 9 to 11 for further details. If the preceding condition applies, but you wish to switch the TV to FTG Mode via EBL, see Reference section, “Restoring Factory Defaults on the TV(s),” for further information before proceeding.

1. Install (if necessary) and launch the FTG Device Configuration Application on the PC that will be used to configure the EBL.
2. Build an FTG Channel Map using the FTG Channel Map Editor in the FTG Channel Map Configuration Utility (or, if applicable, open an existing FTG Configuration [.rml] file).

**Note:** Up to 141 logical channels can be defined in the FTG Channel Map.

3. Connect the PC to the TV-LINK CFG jack on the TV’s rear jack panel using a USB-to-TTL serial cable (TTL-232R-5V-AJ). If necessary, install the device driver on the PC.

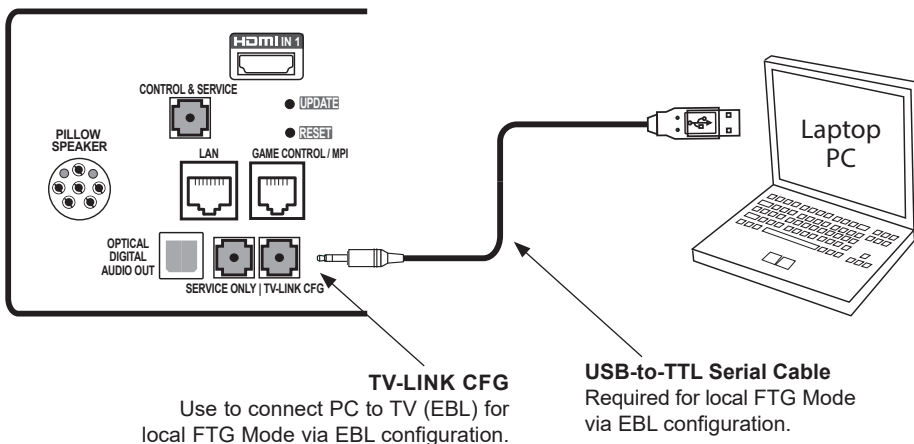

4. Turn ON the TV.

**Note:** If Installer Menu item 118 POWER SAVINGS is set to 3 (default), the TV must be ON in order for steps 6 and 7 to be successful.

(Continued on next page)



## Reference: FTG Mode via EBL (Local Configuration) (Cont.)

---

(Continued from previous page)

5. (Optional) Since the application is no longer being updated with new model profiles, this model is unknown to the application, which means that it is not possible to use the FTG Installer Menu Configuration Utility to change Installer Menu items.

Therefore, if you would like to make any changes to the Installer Menu items, access the Installer Menu on the TV and make the desired/applicable changes to the items BEFORE configuring the EBL for FTG Mode in the next step.

6. "Write" the FTG Channel Map to the EBL (switches the EBL from Pass-through Mode to FTG Mode).

**Note:** After a "Write" of new data, the TV will briefly display a green text banner that shows the EBL firmware version and release date.

7. "Read" the current FTG Installer Menu settings from the EBL using the FTG Installer Menu Configuration Utility.

**Note:** When you "Read" the settings from the EBL, a pop-up notice will be displayed (see example below) to indicate that the chassis ID of this model is unknown and so a generic Installer Menu profile will be loaded. Click **OK** to dismiss the pop-up window and continue. The resulting "generic" profile contains all Installer Menu items, including a number of items that may not be applicable for this model. Refer to the Installer Menu section of this document for detailed information on Installer Menu items that are specific to the US772M.

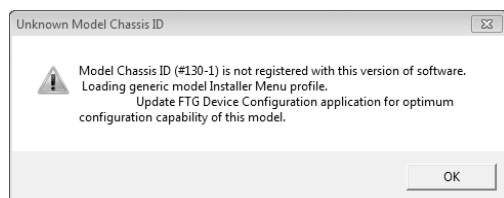

8. Save the FTG Channel Map and FTG Installer Menu settings to an FTG Configuration (.rml) file for future use.
9. Tune the TV to a logical channel in the FTG Channel Map.

**Note:** For information on remote management using an FMA, refer to the appropriate Installation & Configuration document for the FMA in use. For example, for an FMA-LG102, refer to the **FMA-LG102 Installation & Configuration Guide**.

## Reference: Auto Input(s) Sensing Feature

This section provides detailed settings information for Installer Menu item 042 AUTO INPUTS. To disable auto-sensing for all available Aux inputs, set item 042 to 0. To enable auto-sensing for all available Aux inputs, set item 042 to 255. For specifications on all other available settings (i.e., settings for individual inputs), refer to the Aux Inputs Values table on the following page.

**Note:** When both item 042 AUTO INPUTS *and* item 041 SIMPLINK EN are enabled in the Installer Menu, HDMI inputs will be detected by SIMPLINK, but the Auto Input(s) Sensing Feature will not function.

In the Installer Menu, an informational text code is displayed at the right of each Auto Inputs value, for example:

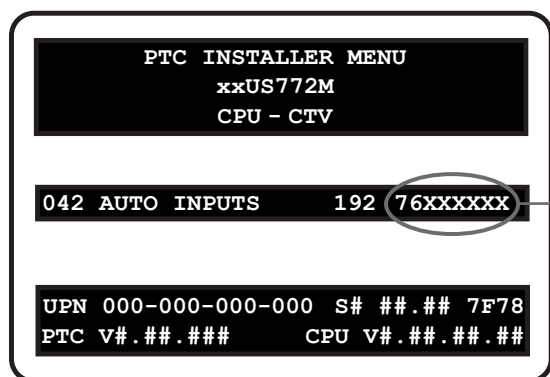

### AUTO INPUTS Text Code

This example illustrates Installer Menu item 042 value 192, which enables auto-sensing for all available Aux inputs. The input #s in the text code (7 & 6 in this example) identify the enabled Aux inputs. See the Input # Assignments table below for a listing of the US772M Aux inputs and their corresponding text code input #s. The Auto Inputs Values table on the following page shows the text codes for all item 042 values.

Each Auto Inputs text code consists of eight characters that identify the Aux input(s) for which auto-sensing is enabled. The following table identifies the Installer Menu text code input # for each Aux input that is available on the US772M TV models. The table also identifies the Installer Menu item associated with each Aux input. Remember that in order for auto-sensing to be enabled for an input, that input must also be enabled in the Installer Menu.

### Input # Assignments

Installer Menu Text Code Input #	Aux Input	Installer Menu	
		Item	Function
6	HDMI 1	035	HDMI1 ENABLE
7	HDMI 2	091	HDMI2 ENABLE

## Reference: Auto Input(s) Sensing Feature (Cont.)

---

The following table shows all available Aux inputs as if each is enabled in the Installer Menu. The Installer Menu text codes for item 042 will be altered accordingly if any of the available Aux inputs are disabled in the Installer Menu.

### Auto Inputs Values

Item 042 Value	Aux Inputs		Installer Menu Text Code
	HDMI 1	HDMI 2	
000	Disabled	Disabled	DDXXXXXX
064	Enabled	Disabled	D6XXXXXX
128	Disabled	Enabled	7DXXXXXX
192	Enabled	Enabled	76XXXXXX
255	Enabled	Enabled	76XXXXXX

X = Aux input is Disabled or Not Available (i.e., on these TV models)

D = Auto-sensing for input is Disabled

Input # = Auto-sensing for input is Enabled

# Reference: US772M Hospital Operations

## Hospital Features

The following table identifies when and how the US772M hospital features are supported in three different TV configurations. As indicated in the introduction to this document, LG commercial TV functionality is based on “ownership” of the Channel Map. For the purposes of this table, “CPU” indicates that the TV is in Pass-through Mode with the Channel Map in the CPU (i.e., auto-tuned/edited channel lineup) and “PTC” indicates that the TV is in Pass-through Mode with the Channel Map in the PTC (PTC-CTV Mode).

Hospital Mode State	Item	CPU		PTC		FTG/PPV Mode	
		Disabled	Enabled	Disabled	Enabled	Disabled	Enabled
Installer Menu	Item						
IR Banks Enable	012				X		
Scan Mode	013			X	X	X*	X*
Start Channel in Scan Mode	014			X	X	X*	X*
Feature Level	020						
Zenith Bed 1/Bed 2	020	X		X		X	
LG Multi-code IR	020	X	X	X	X	X	X
Speaker (TV or Pillow Only)	020	X		X		X	
Function Preview	025			X	X		
Hospital Mode	027						
Zenith Bed 1/Bed 2	027		X		X		X
Pillow Speaker Voltage	027	(a)	X	(a)	X	(a)	X
Speaker (TV or Pillow or Both)	027		X		X		X
Quick Shutoff	077	(b)	(b)	(b)	(b)	(b)	(b)
Channel Banks							
Number of Banks Enabled				1	4	1	4*
Channel Preview/Banks Setup Menu				X	X		
Blanked Channel				X	X	X	X
Inactive TV					X		X*
SAP Key (special use in Channel Preview/Banks Setup Menu)					X		
Aux Input Sources							
Input List Menu (Zenith CH BANK Key)		X	X	X		X	X**
Aux in Channel Lineup				X	X	(c)	X*/(c)
TV Setup Menus							
Sound Out (TV Speaker)		(d)	(d)	(d)	(d)	(d)	(d)
General (Standby Light)		X	X	X	X		

\* Applicable for FTG Mode via CPU only.      \*\* Applicable for FTG Mode via EBL only.

X = feature supported

- a) Zenith pillow speaker code/(+12v) supply voltage. (When Installer Menu item 027 is set to 254 [factory default value], there is no power [voltage] supplied to the pillow speaker interface.)
- b) The Quick Shutoff feature only functions when Scan Mode is enabled and if you are using an analog pillow speaker.
- c) Dependent upon installer-defined FTG/PPV Channel Map.
- d) The Sound Out Menu is not accessible when the speaker selection in the Installer Menu (i.e., item 020 or 027) is “Pillow Only” or if Installer Menu item 049 DIS. AUDIO M. is set to a value that disables the Sound Out Menu.

## Reference: US772M Hospital Operations (Cont.)

### Speaker Selection

The following table identifies the speaker sound source as determined by Installer Menu items 027 HOSPITAL MODE and 020 FEATURE LEVEL and the Sound Out Menu setting.

**Note:** The Sound Out Menu is not accessible when the speaker selection in the Installer Menu (i.e., item 020 or 027) is "Pillow Only" or if Installer Menu item 049 DIS. AUDIO M. is set to a value that disables the Sound Out Menu.

Item 027 HOSPITAL MODE Value	Item 020 FEATURE LEVEL Value	Sound Out Menu Setting	Sound Source
0	0–31 *	TV Speaker	TV (Internal) Speaker
0	0–31 *	External Speaker	External Speaker **
0	64–65	N/A	Pillow Speaker
1–34	N/A	N/A	Pillow Speaker
65–98	N/A	TV Speaker	TV (Internal) Speaker
65–98	N/A	External Speaker	External Speaker **
129–162	N/A	TV Speaker	Pillow Speaker and TV (Internal) Speaker
129–162	N/A	External Speaker	Pillow Speaker and External Speaker

\* Values 25–31 applicable with PTC v1.00.011 or later.

\*\* You will only hear sound if an external speaker is connected to the TV.

# Reference: Restoring Factory Defaults on the TV(s)

---

This section describes how to restore all factory defaults or just the Installer Menu factory defaults either on a single TV that is currently in Pass-through Mode, FTG Mode, Application Tuning Mode, etc. or on multiple TVs that are currently in FTG Mode.

## Restore All Factory Defaults

This section describes how to restore a single TV, regardless of its mode, to a factory default condition. The following procedure requires that you contact LG technical support to obtain a predefined value/password for Installer Menu item 117 FACT DEFAULT that enables access to initiate a factory “IN-STOP” process, which restores all factory defaults. This procedure will also reactivate the First Use Wizard.

1. Use the Installer Remote to access the TV’s Installer Menu, navigate to Installer Menu item 117 FACT DEFAULT, and key in the value provided by technical support. Then, press **OK**.
2. At the prompt for confirmation, key in the password provided by technical support. This will initiate the IN-STOP that restores the factory defaults on the TV.

## Installer Menu Item 117 FACT DEFAULT

If the TV is currently in Pass-through Mode, you can set Installer Menu item 117 FACT DEFAULT to 1 to restore the Installer Menu factory defaults and clear the PTC Channel Map, including any assigned channel icons and custom text labels. Note, however, that if a complete restoration of the TV’s factory defaults is required, see “Restore All Factory Defaults” above.

## Additional FTG Mode via CPU Options

There are two additional options for restoring Pass-through Mode/Installer Menu factory defaults on TVs that are in FTG Mode via the CPU. The first enables you to restore a single TV to Pass-through Mode, while the second enables you to restore multiple TVs to Pass-through Mode at one time. However, both options require that you create a “Restore\_Pass-through\_Mode.tlx” file, i.e., an FTG Configuration file with no data. Refer to the **Cloud Configuration Tool User Guide** for further information.

- Using a USB memory device, import a “Restore\_Pass-through\_Mode.tlx” file to the TV. Refer to “Importing a Clone File” on pages 82 to 85 for further information on the import procedure.
- If your system uses a Pro:Centric server for remote management of US772M TVs that are in FTG Mode, use the Pro:Centric Admin Client to load a “Restore\_Pass-through\_Mode.tlx” file on the Pro:Centric server. Refer to the **Pro:Centric Server Admin Client User Guide** for further information.

## Additional FTG Mode via EBL Options

There are two additional options for restoring Pass-through Mode/factory defaults on TVs that are in FTG Mode via the EBL. The first enables you to restore a single TV to Pass-through Mode, while the second enables you to restore multiple TVs to Pass-through Mode at one time.



**Note:** While the IN-STOP process described above will clear both the PTC and the CPU, both options below only clear the PTC. Thus, the current Channel Map and TV setup menu settings will remain in the CPU after the reset is completed.

- Using a direct PC-to-TV connection, “Write” an unpopulated Channel Map—that is, a Channel Map with 0 (zero) channels—to the TV. See Reference section, “FTG Mode via EBL (Local Configuration),” and/or the **Free-To-Guest (FTG) Device Configuration Application User Guide** for further information.
- If your system uses an FMA for remote management/broadcast configuration, configure the FMA device with an FMA Configuration (.fma) file that only contains a “0 Mapped Channels” FTG Channel Map to broadcast to the TV EBL(s). Refer to the **Free-To-Guest (FTG) Device Configuration Application User Guide** and/or the Installation & Configuration Guide for the FMA device for further information.

# Reference: Using the TV's Zoning Features

---

This section describes the TV Zoning and Wi-Fi Zoning features available with the US772M model TVs. These features are primarily intended for use when the TV is configured for FTG Mode via CPU operation; however, Wi-Fi Zoning, along with selected elements of TV Zoning (Installer Menu and Setup Menu profile Zone assignments), may also be used with TV cloning processes using a Clone (.tlx) file. Refer to the appropriate section(s) below for further information on the Zoning features and how to set the TV Zone # and/or Wi-Fi Zone # in a TV that is currently in Pass-through Mode.



**Note: Hospital Mode channel banks and Lodging TV Zoning are mutually exclusive features of these TV models. The TV Zoning feature is only available when Hospital Mode is disabled (i.e., Installer Menu item 027 HOSPITAL MODE is set to 0). For additional information, see “Channel Banks Overview” on pages 40 to 42.**

## TV Zoning Feature

The TV Zoning feature enables you to create localized configurations for TVs in selected “Zones” within the installation site, for example, a lobby area, fitness center, restaurant, etc.

### Using the TV Zoning Feature with FTG Mode Configuration

The Cloud Configuration Tool may be used to create an FTG Configuration (.tlx) file that contains multiple Installer Menu and Setup Menu profiles, each with its own Zone assignment. Up to nine unique Zones can be designated for US772M FTG Installer Menu and/or Setup Menu profiles. Zone restrictions can also be placed on individual channels in the FTG Channel Map. Thus, for example, you may create an FTG Installer Menu and/or Setup Menu profile to uniquely configure a TV in the fitness center and also restrict the channels that are available to be tuned on that TV.

The TV Zone # must be set appropriately on each TV in order for the TVs to be configured correctly. See “Set the TV Zone # and/or Wi-Fi Zone # in the TV” on page 131, and set the TV Zone # in all the TVs in a select area, so that the TVs are configured with corresponding FTG Installer Menu and/or Setup Menu settings and/or can omit channels that have been restricted in the FTG Channel Map. TV Zone 0 is the default TV Zone #.

The following subsections briefly describe how to assign Zones in the Cloud Configuration Tool. Refer to the **Cloud Configuration Tool User Guide** for further information.

#### *FTG Installer Menu Profile Zone Assignments*

The Cloud Configuration Tool / Installer Menu web page enables you to create multiple Installer Menu profiles for the same chassis model, each with a different Zone assignment (default = Zone 0), to be included in an FTG Configuration (.tlx) file. For example, you may wish to create one Installer Menu profile for the US772M TV in the lobby area and another Installer Menu profile for the US772M TV in the fitness center, both of which are different from the Installer Menu profile used for US772M TVs in standard patient rooms. The TV Zoning feature enables you to save multiple US772M FTG Installer Menu profiles, each with its own Zone assignment, in one FTG Configuration file. If each TV in each location (Zone) has had its TV Zone # set appropriately, as described in the procedure on page 131 or in the Advanced Settings / EZ-Manager Wizard or Hospital Setup Wizard, the TV(s) will only be configured by the Installer Menu profile that matches its(their) Zone setting.

In the Cloud Configuration Tool / File Manager web page, you can also change the Zone assignment for each Setup Menu profile already present in the FTG Configuration List. See the File Manager and Installer Menu web page overviews on pages 89 and 92 for further information. Note that Setup Menu profiles cannot be created in the Cloud Configuration Tool; they must be saved (exported) from a TV.



## Reference: Using the TV's Zoning Features (Cont.)

---

### *FTG Channel Map Zone Restrictions*

In the Cloud Configuration Tool / Channel Map web page, you can place Zone restrictions on individual channels that may be prohibited or deemed unsuitable for certain locations. One or more Zone restrictions (1–8) may be placed on each channel that is to be restricted. For example, if you wish to restrict a channel from Zones 2 and 4, select both “Zone 2” and “Zone 4” in the Restricted from Zones field when defining or editing that channel.

**Note:** While a channel can be restricted from up to eight Zones, a TV can only ever be in (set for) one Zone. See also the Channel Map web page overview on page 90.

At the same time, keep in mind that the TV Zone designations are not mutually exclusive. That is, you may opt to place Zone restrictions on selected channels in the FTG Channel Map, but at the same time, you can choose to configure all TVs at the site with the same Installer Menu and/or Setup Menu settings. For example, an FTG Configuration (.tlx) file being used to configure the TVs at a site may contain multiple Installer Menu and Setup Menu profiles with different Zone assignments, as well as an FTG Channel Map with Zone restrictions on several channels. Each TV that still has the default TV Zone 0 setting will *only* be configured by the Installer Menu and/or Setup Menu profile(s) with a Zone 0 designation. If, on the other hand, the TV Zone # is set to 1, the TV will first look in the file for the US772M Installer Menu and/or Setup Menu profile(s) with a Zone 1 designation. If none of the US772M Installer Menu and/or Setup Menu profiles has a Zone 1 designation, the TV will then look for the US772M profile(s) with a Zone 0 designation. For the FTG Channel Map configuration, when the TV Zone # is set to 0, the TV will ignore any Zone restrictions (1–8) that may be placed on channels in the FTG Channel Map. However, when the TV Zone # is set to 1, the TV will omit any channels that have been restricted from Zone 1 in the FTG Channel Map.

### **Using the TV Zoning Feature with Cloning Configuration**

A location-specific configuration / Clone (.tlx) file may be saved (exported) from a Master TV and then be used to configure Target TVs. For example, if the TV Zone # in the Master TV is set to 3 before the Clone file export is initiated, the Master TV's Installer Menu and Setup Menu profiles will be saved with the TV Zone 3 assignment. In order to configure the Target TVs with the Zone 3 Installer Menu and Setup Menu profiles exported from the Master TV, you must set the TV Zone # accordingly in the Target TVs before importing the Clone file. See “Set the TV Zone # and/or Wi-Fi Zone # in the TV” on the following page. Also, see “Cloning Procedures” on pages 79 to 85 for additional information on the cloning processes. TV Zone 0 is the default TV Zone #.

### **Wi-Fi Zoning Feature**

The Wi-Fi Zoning feature enables you to use a Clone/Configuration (.tlx) file to configure an individual TV or group of TVs with a particular Wi-Fi access point's login data to create “Wi-Fi Zones” within the installation environment.

### **Using the Wi-Fi Zoning Feature with FTG Mode Configuration**

The Cloud Configuration Tool may be used to create an FTG Configuration (.tlx) file with an FTG Installer Menu profile that contains login data for multiple Wi-Fi access points, each assigned a Wi-Fi Zone #. Up to 100 Wi-Fi Zones can be designated within each FTG Installer Menu profile, thus allowing for distribution of the Wi-Fi network load. For example, if a site has 50 US772M TVs within close proximity, you may wish to create 10 Wi-Fi Zones, each with its own access point that has unique login data, so that no more than five of the TVs are connected to one access point at any given time.

## Reference: Using the TV's Zoning Features (Cont.)

---

In order for a TV to be configured by the proper Installer Menu profile with the desired Wi-Fi access point login data for wireless networking (i.e., SSID, security type, and security key), you must set both the TV Zone # and the Wi-Fi Zone # in the TV (see “Set the TV Zone # and/or Wi-Fi Zone # in the TV” below for further information). If the Wi-Fi Zone # in the TV is set to 0 (default), the TV will not obtain access point login data from the Installer Menu profile with which it is configured unless the profile contains the global Wi-Fi Zone 100. Any TV that does not find its matching Wi-Fi Zone # in the FTG Configuration file, but does find the global Wi-Fi Zone 100, will be configured with the global access point login data.

Refer to the **Cloud Configuration Tool User Guide** for further information on defining Wi-Fi Zones in the Cloud Configuration Tool.

### Using the Wi-Fi Zoning Feature with Cloning Configuration

A location-specific Wi-Fi configuration / Clone (.tlx) file may be saved (exported) from a Master TV and then be used to configure Target TVs. First, the wireless network (i.e., the access point login data) must be configured in the Master TV's IP Environment Menu (see “Configuring a Wi-Fi Network Connection” on pages 95 to 96). Then, a Wi-Fi Zone # must be set in the Master TV (see “Set the TV Zone # and/or Wi-Fi Zone # in the TV” below). If desired, a TV Zone # may also be set in the Master TV.

For example, if the Wi-Fi Zone # is set to 4 and the TV Zone # is set to 5 before the Clone file export is initiated, the Master TV's Installer Menu profile will be saved with the Zone 5 assignment, and within that Installer Menu profile, the access point login data for wireless networking (i.e., SSID, security type, and security key) will be saved with a Wi-Fi Zone 4 assignment. In order to configure the Target TVs with the proper Installer Menu profile and access point login data, you must set both the TV Zone # and the Wi-Fi Zone # in the Target TVs accordingly before importing the Clone file. See “Set the TV Zone # and/or Wi-Fi Zone # in the TV” below. Also, see “Cloning Procedures” on pages 79 to 85 for additional information on the cloning processes. If the Wi-Fi Zone # in the TV is set to 0 (default), the TV will not obtain access point login data from the Installer Menu profile with which it is configured unless the profile contains the global Wi-Fi Zone 100. Any TV that does not find its matching Wi-Fi Zone # in the Clone file, but does find the global Wi-Fi Zone 100, will be configured with the global access point login data.

### Set the TV Zone # and/or Wi-Fi Zone # in the TV

You can set the TV Zone # and/or the Wi-Fi Zone # in the Advanced Settings / EZ-Manager Wizard or the Hospital Setup Wizard (see “First Use Wizard” on pages 19 to 21) or, if the TV is in Pass-through Mode, via the TV's setup menus as described below. Note that the following procedure can only be performed while the TV is in Pass-through Mode. You will also be able to specify a Label (North, South, East, West) and Room Number for this TV, if desired.

1. Turn ON the TV.
2. Press **MENU** on the Installer Remote, and use the arrow navigation keys to select/highlight the **General** menu option. Then, press **OK**.
3. In the General Menu, use the Up/Down arrow keys to select **Room Info**, and then press **OK**.
4. In the Room Info screen, complete the appropriate fields as described below. Use the Up/Down arrow keys on the Installer Remote to navigate between each of the fields.

(Continued on next page)

## Reference: Using the TV's Zoning Features (Cont.)

(Continued from previous page)

- **Wi-Fi Zone:** Enables you to set a Wi-Fi Zone # so that the TV can be configured with a particular access point's login data for wireless networking. Login data (i.e., SSID, security type, and security key) may be provided in a Clone/Configuration (.tlx) file.  
To assign a Wi-Fi Zone, select/highlight the **Wi-Fi Zone** field and press **OK**. Then, use the Left/Right arrow keys to specify the desired Wi-Fi Zone # (1–99). Press **OK** when you are finished.
- **TV Zone:** Enables you to set a TV Zone # so that the TV can be configured with Installer Menu and/or Setup Menu settings intended only for the assigned Zone. The Installer Menu and/or Setup Menu settings may be provided in a Clone/Configuration (.tlx) file. If the TV is being configured for FTG Mode, the TV Zone # setting also allows the TV to omit channels that have been restricted in the FTG Channel Map (see “FTG Channel Map Zone Restrictions” on page 130).  
To change the TV Zone, select/highlight the **TV Zone** field and press **OK**. Then, use the Left/Right arrow keys to specify the desired TV Zone # (0–8). Press **OK** when you are finished.
- **Label:** Allows you to select a North, South, East, or West text label for this TV. Select/highlight the **Label** field and press **OK**. Then, use the Up/Down arrow keys to select the applicable label. Press **OK** when you are finished.
- **Room Number:** Allows you to specify the number of the room—up to 16 characters—in which the TV is located. To enter a room number, use the Up/Down arrow keys to select/highlight the **Room Number** field and press **OK**. You can then use the number keys on the Installer Remote to direct enter a room number, or you can use the arrow keys to select the appropriate alphanumeric character(s) from the pop-up virtual keyboard at the bottom of the screen. When you are done, select **Enter** from the virtual keyboard, and then press **OK** on the Installer Remote.

**Note:** The TV name (default: “[LG] webOS TV” + the TV’s model name) will be changed to the room number specified here. See “Media Share Setup” on pages 107 to 109 for further information on the TV name.

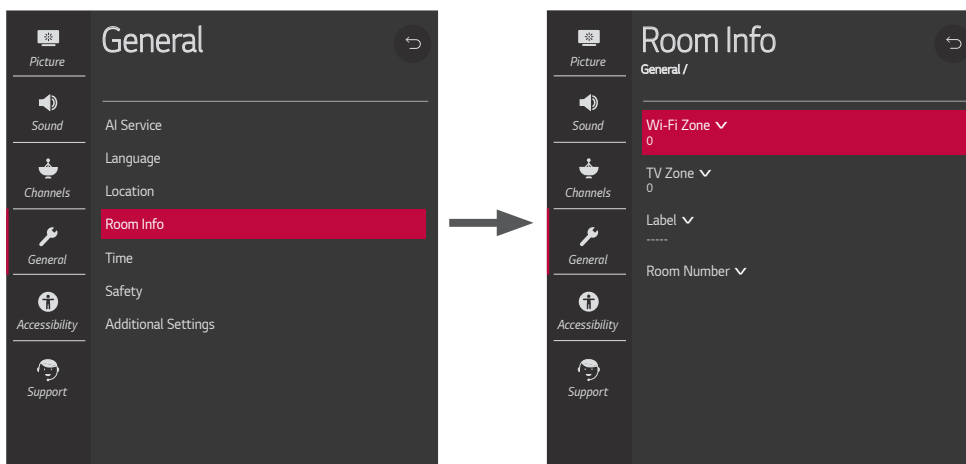

5. When you have completed the fields as necessary, press **↵** to return to and/or exit the TV menus, or press **MENU** to return to program viewing.

When the appropriate Media Share options are enabled in the IP Environment / Media Share Menu, end users have the ability to use one or more of the Media Share features. See also “Media Share Setup” on pages 107 to 109.

This section provides an overview of the Smart Share, Screen Share, DIAL, and SoftAP functionality.



**Note: Typically, only one Media Share feature may be used at a time. If one feature is currently in use, you may have to exit or turn it off in order to use/turn on another. In some cases, you will be prompted to confirm your action. Follow the display prompts as necessary.**

## Smart Share (DLNA Certified Devices)

The following steps describe how to access and use the Smart Share feature with DLNA Certified devices on the same LAN as the TV.

1. Turn ON the TV, and then use one of the following methods to access media files/folders, depending on the current configuration of the TV:
  - If the Pro:Centric application is not loaded, press **PORTAL** on the Installer Remote, and use the Left/Right arrow keys to select **Music** or **Photo & Video** from the TV's Smart Launcher.  
**Note:** Depending on the remote control being used, you may also access the Smart Launcher via the SMART key.
  - If the Pro:Centric application is loaded, press **MENU** on the Installer Remote to display the Function Menu, use the Up/Down arrow keys to select/highlight the **General** menu icon, and then press **OK**. In the General Menu, use the Up/Down arrow keys to select **Music** or **Photo & Video**.
2. In the next screen (Music or Photo & Video, depending on your selection in the previous step), select the desired Smart Share device, and then select the desired file(s) to view.

## Screen Share (Miracast / WiDi)

The following steps describe how to access and use the Screen Share feature to select a Miracast or WiDi capable device, whose screen can be displayed on the TV.

1. Turn ON the TV, and then use one of the following methods to access Screen Share, depending on the current configuration of the TV:
    - If the Pro:Centric application is not loaded, press **PORTAL** on the Installer Remote, and use the Left/Right arrow keys to select **Screen Share** from the TV's Smart Launcher.  
**Note:** Depending on the remote control being used, you may also access the Smart Launcher via the SMART key.
    - If the Pro:Centric application is loaded, press **MENU** on the Installer Remote to display the Function Menu, use the Up/Down arrow keys to select/highlight the **General** menu icon, and then press **OK**. In the General Menu, use the Up/Down arrow keys to select **Screen Share**.
- Note:** If Screen Share is not currently available/accessible in the Smart Launcher or Function Menu, you may need to exit/turn off another Media Share feature in order to use Screen Share. For example, select **Wi-Fi Service** (SoftAP) in the TV's Smart Launcher, and make sure that SoftAP is turned off. See also note above regarding simultaneous use of Media Share features.

(Continued on next page)

## Reference: Using Media Share Features (Cont.)

---

(Continued from previous page)

2. Follow the on-screen instructions to initiate the Miracast / WiDi connection from your Miracast / WiDi device. Note that you may be prompted to enter a PIN number that appears on the TV screen into your Miracast / WiDi connection window to complete the connection.

Once the connection is established, the TV display may be used as a second screen for the Miracast / WiDi device.

### DIAL

The following steps describe how to access and use DIAL. Remember that the device used **MUST** be connected to the same network as the TV.

**Note:** DIAL may only be used with device applications for which a TV-compatible application (for example, YouTube) has been created/selected for inclusion in the Pre-loaded Apps Menu (see “Pre-loaded Applications” on page 105).

1. Turn ON the TV.
2. On your device, launch the desired application (see also note above, regarding the Pre-loaded Apps requirement), and use the appropriate options, typically available via Settings, to initiate a connection/pairing with the TV. You may also need to access the Settings options from the application on the TV to complete the pairing operation. Follow the on-screen instructions.

Once the connection/pairing is successful, you will be able to view media from the application on the TV.

### SoftAP

The following steps describe how to access and use the SoftAP (Wi-Fi Service) feature.

1. Turn ON the TV, and then use one of the following methods to access SoftAP, depending on the current configuration of the TV:
  - If the Pro:Centric application is not loaded, press **PORTAL** on the Installer Remote, and use the Left/Right arrow keys to select **Wi-Fi Service** from the TV's Smart Launcher.  
**Note:** Depending on the remote control being used, you may also access the Smart Launcher via the SMART key.
  - If the Pro:Centric application is loaded, press **MENU** on the Installer Remote to display the Function Menu, use the Up/Down arrow keys to select/highlight the **General** menu icon, and then press **OK**. In the General Menu, use the Up/Down arrow keys to select **SoftAP**.

**Note:** If SoftAP is not currently accessible, or if a message is displayed indicating that Wi-Fi Service is not currently available, make sure a wired LAN connection to the TV has been established.
2. When you initially access the SoftAP or Wi-Fi Service screen, the Off/On toggle button at the top right of the screen is selected/highlighted by default. If it is currently off, press **OK** on the Installer Remote to turn on SoftAP/Wi-Fi Service. When SoftAP/Wi-Fi Service is on, the SoftAP access information, including the SSID and security key, is displayed in the lower half of the screen.

(Continued on next page)

## Reference: Using Media Share Features (Cont.)

---

(Continued from previous page)

3. Make sure Wi-Fi is turned on on your device, and then use the access information provided to initiate a connection to the TV's network.

Once a device is connected successfully to the TV's network, you can use it to access the Internet. Up to 10 devices may be connected at a time, though excessive use by some devices may diminish the performance of other devices and/or cause them to disconnect.

**Note:** A wired network connection MUST be established in order for end users to use SoftAP/Wi-Fi Service. Also, the SoftAP/Wi-Fi Service feature may only be used while the TV is turned ON.

**Note:** SoftAP supports both 2.4 GHz and 5 GHz Wi-Fi frequencies. If you are having difficulty with one Wi-Fi frequency, try the other.

# Reference: US772M Rear and Side Jack Panels

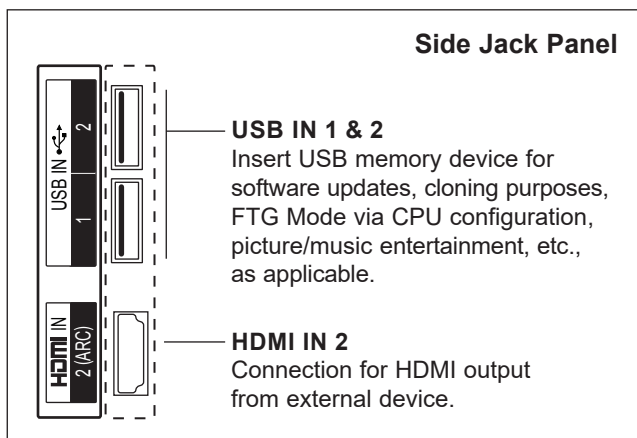
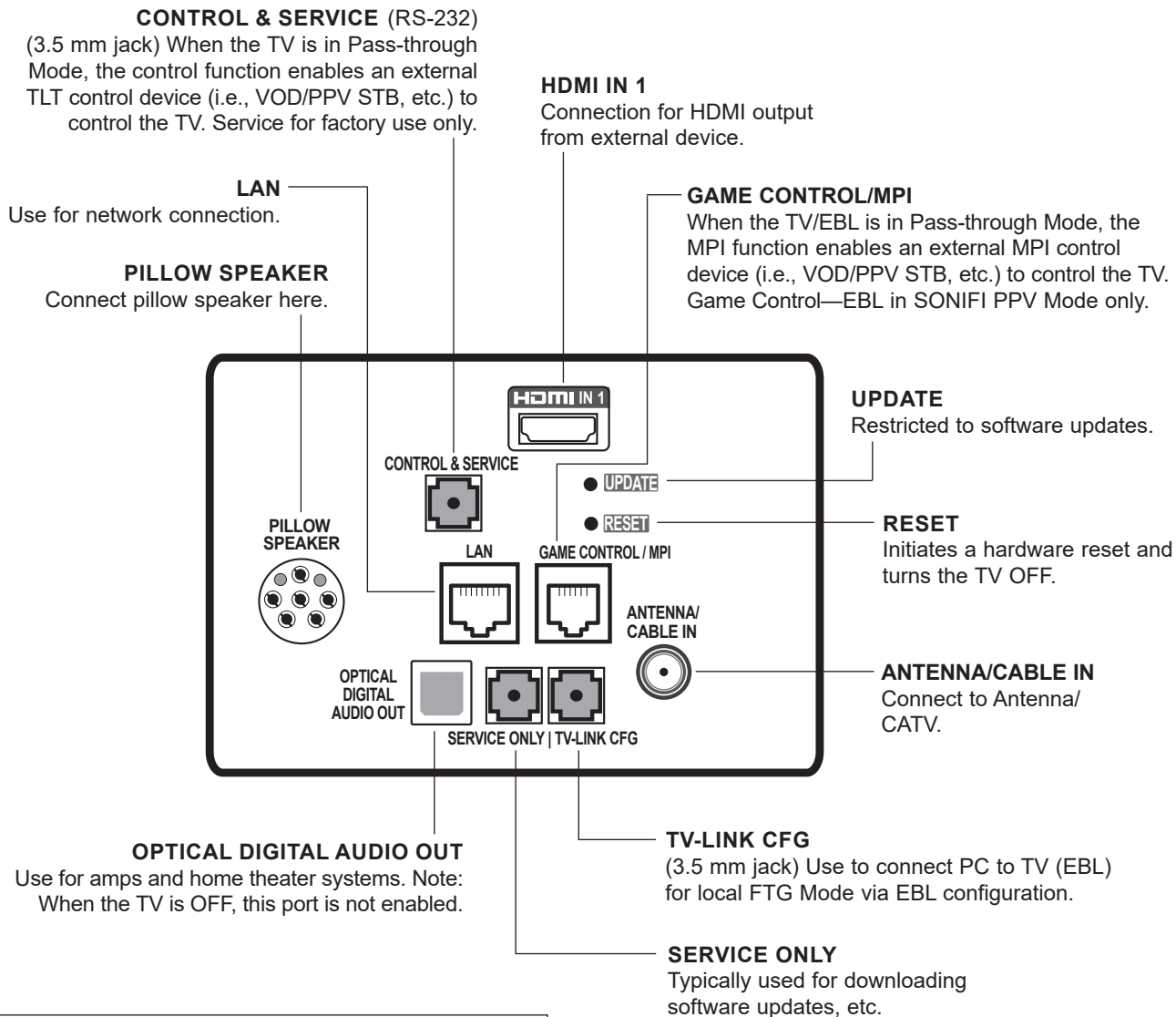



# Reference: Installer Remote Control Typical Key Functions

An LG Installer Remote is required to set up and operate the TV. The LG Installer Remote illustrated below shows typical remote control functions and is provided for reference only.

**Note:** The LG Slate Installer Remote available for hospital models also is capable of supporting LG multi-code or Zenith IR schemes. See “Setting the Patient Remote IR Code Scheme” under Reference section, “LG Pro:Centric Patient Remote and Pillow Speaker;” the same procedures may be performed on the Slate Installer Remote.

- VD** 

Enables VD function.
- CC**

Displays Closed Caption options. Closed Caption availability varies by program.
- Arrows (Up/Down/Left/Right) & OK**

Use to navigate on-screen menus, direct tune channels in program guides, or adjust TV settings.
- ↶ (RETURN)** 

Returns one level to the previous menu/display.
- ✕ (EXIT)** 

Clears all on-screen displays and returns to program viewing.
- VOLUME UP/DOWN**

Increases/decreases sound level.
- MENU**

Displays and removes the TV setup menus (or, if applicable, the Function Menu).
- 🔇 (MUTE)**

Switches sound ON or OFF.
- CHANNEL UP/DOWN**

Changes channels based on channels in the channel lineup.
- Color buttons** 

Color buttons access special functions in some menus.



## INPUT / CH BANK

Selects Channel Bank 1, 2, 3, or 4 when Hospital Mode is enabled and TV is in PTC-CTV Mode or FTG Mode via CPU (applicable for Zenith IR schemes only). Otherwise, this button displays available Aux inputs.

## 🔌 (POWER)

Turns the TV ON or OFF.

## SMART

Displays the TV's Smart Launcher.

## SAP

Displays Multi Audio or Audio Language options, i.e., additional audio content(s)/ language(s), if available.\*

## TIMER

Sets the amount of time before the TV automatically turns itself OFF.

## GUIDE

Displays and removes the Pro:Centric channel guide/EPG.

## PORTAL

Displays and removes the Pro:Centric interactive menu.

## INFO

Displays channel information.

## Numbers (0 - 9) & DASH

Use to enter a channel or channel and program number. Dash is keyed in between channel number and program number to enter digital channels, such as 9-1, 9-2, etc.

## LAST

Returns to the previously tuned channel.

## \* SAP notes:

- Each channel may have its own SAP setting.
- If SAP is selected and no SAP is provided, sound may not be heard on channel.
- Each time digital channels are tuned, the TV attempts to locate the default audio program language. If the default audio program language is not available, the TV will use the first available audio program.

 Denotes a feature that is applicable for LG IR schemes only.

# Reference: LG Pro:Centric Patient Remote and Pillow Speaker

LG Pro:Centric patient remotes and/or pillow speakers are available for purchase. For additional information and/or to purchase an LG Pro:Centric patient remote (see note below) or pillow speaker, please contact your LG Sales representative or distributor.

**Note:** Two versions of Slate Pro:Centric Healthcare remote controls are available from LG. The Slate remote with a black case provides full Installer Remote functionality (see example on previous page) while the Slate remote with a white case has been designed for patient use and is not useful for installation purposes (see example below).

## Patient Remote and Pillow Speaker Functionality

Both the LG Pro:Centric patient remote and the LG Pro:Centric pillow speaker provide access to Pro:Centric application features (via PORTAL, INFO, and GUIDE buttons). See also “Installer Remote Control Typical Key Functions” on the previous page for further information on button functions. The patient remote also is capable of supporting LG multi-code or Zenith IR schemes as described on the following pages.



Typical LG Pro:Centric Patient Remote

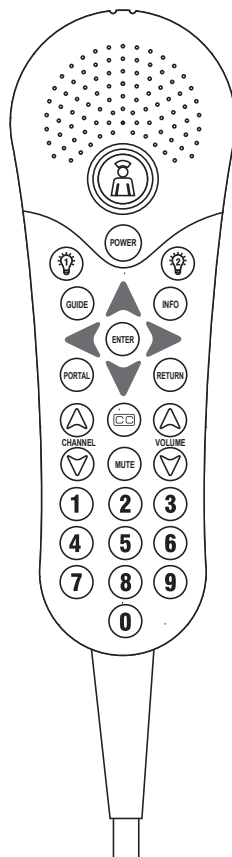

Typical LG Pro:Centric Pillow Speaker

# Reference: LG Pro:Centric Patient Remote and Pillow Speaker (Cont.)

## Setting the Patient Remote IR Code Scheme

Refer to the appropriate subsection below for LG or Zenith IR schemes.

**Note:** The TV will always respond to the standard LG Installer Remote IR code scheme, i.e., you can always use an Installer Remote with the TV, regardless of its LG multi-code or Zenith Bed IR setting.

### LG Multi-code IR Feature

This section describes how to set an LG Slate patient remote to send unique LG IR codes based on “bed number” (Bed 1 to Bed 16) in a multi-TV single room installation.

**Note:** LG multi-code IR supports LG Pro:Centric application features.

The following procedure requires/assumes that Installer Menu item 020 FEATURE LEVEL has been set to the desired value 16–31 (Bed 1–Bed 16). If necessary, access the Installer Menu to set or check the value of item 020, as needed. You can also use the Cloud Configuration Tool to configure this setting, if preferred. See Installer Menu and/or Cloud Configuration Tool sections in this document for further information.

The patient remote must be set to match the TV’s setting. That is, if item 020 is set to 17 for Bed 2, the patient remote must also be set to multi-code Bed 2.

**Note:** By default, the patient remote IR scheme is the same as the standard LG Installer Remote IR scheme.

1. On the patient remote, press and hold the **INPUT** key until the LED that lights the  $\phi$  (POWER) key blinks twice (about five seconds).
2. Press the **SMART** key on the remote to enter programming mode.
3. Use the number keys on the remote to key in the five-digit code for the desired LG Bed number—refer to the table below for bed codes.

After a valid code is entered, the remote LED will blink rapidly two times to indicate the setup is complete.

4. Verify that the patient remote now controls the TV, based on your settings.

**Note:** If necessary, you can restore the patient remote IR scheme to the standard LG Installer Remote IR scheme by repeating steps 1 to 3 above using LG Bed “0” (code: 00000). Use an Installer Remote to update Installer Menu item 020, as needed.

Bed #	Code	Bed #	Code
LG Bed 1	00001	LG Bed 9	00009
LG Bed 2	00002	LG Bed 10	00010
LG Bed 3	00003	LG Bed 11	00011
LG Bed 4	00004	LG Bed 12	00012
LG Bed 5	00005	LG Bed 13	00013
LG Bed 6	00006	LG Bed 14	00014
LG Bed 7	00007	LG Bed 15	00015
LG Bed 8	00008	LG Bed 16	00016

# Reference: LG Pro:Centric Patient Remote and Pillow Speaker (Cont.)

---

## Zenith Bed IR Feature

This section describes how to set the LG Pro:Centric patient remote to send unique Zenith IR codes for Bed 1 or Bed 2 in a multi-TV single room installation.



**Note: Zenith IR does not support LG Pro:Centric application features. Also, attempting to set unique IR schemes for multi-TV single room installations is NOT recommended when wired pillow speakers are installed.**

The following procedure requires/assumes that Installer Menu items 027 HOSPITAL MODE and 020 FEATURE LEVEL have been set to the desired values. For Zenith IR purposes, Hospital Mode may be set to 0, 65, or 66. If Hospital Mode is set to 0, Feature Level/IR Control should be set to 0 or 1 (Bed 1 or Bed 2) to determine the Zenith IR scheme. If necessary, access the Installer Menu to set or check the values of items 020 and 027, as needed. You can also use the Cloud Configuration Tool to configure the setting(s), if preferred. See Installer Menu and/or Cloud Configuration Tool sections in this document for further information.

The patient remote must be set to match the TV's setting. For example, if item 020 is set to 1 for Bed 2, the patient remote must also be set to Bed 2.

**Note:** By default, the patient remote IR scheme is the same as the standard LG Installer Remote IR scheme.

1. On the patient remote, press and hold the **INPUT** key until the LED that lights the  $\phi$  (POWER) key blinks twice (about five seconds).
2. Press the **SMART** key on the remote to enter programming mode.
3. Use the number keys on the remote to key in the five-digit code for the desired Zenith Bed number—refer to the table below for bed codes.

After a valid code is entered, the remote LED will blink rapidly two times to indicate the setup is complete.

4. Verify that the patient remote now controls the TV, based on your settings.

**Note:** If necessary, you can restore the patient remote IR scheme to the standard LG Installer Remote IR scheme by repeating steps 1 to 3 above using LG Bed "0" (code: 00000). Use an Installer Remote to update Installer Menu items 020 or 027, as needed.

Bed #	Code
Zenith Bed 1	01111
Zenith Bed 2	02222

## USB Media Navigation

This section provides a brief overview of the LG Pro:Centric patient remote and LG Pro:Centric pillow speaker navigation tools for use with USB media files (photos, videos, music, etc.).

**Note:** The LG Pro:Centric pillow speaker is currently the only pillow speaker that enables users to navigate and play/view USB media files.

**Note:** Refer to the Owner's Manual for detailed information on USB memory device requirements and the types of media supported by the US772M TVs.

## Reference: LG Pro:Centric Patient Remote and Pillow Speaker (Cont.)

---

1. Insert the USB memory device into either of the TV's USB ports, and then use one of the following methods to access the Media Player:
  - If the Pro:Centric application is not loaded, press **PORTAL** on the Installer Remote, and use the Left/Right arrow keys to select **Media Player** from the TV's Smart Launcher.  
**Note:** Depending on the remote control being used, you may also access the Smart Launcher via the SMART key.
  - If the Pro:Centric application is loaded, press **MENU** on the Installer Remote to display the Function Menu, use the Up/Down arrow keys to select/highlight the **General** menu icon, and then press **OK**. In the General Menu, use the Up/Down arrow keys to select **Media Player**.
2. With the Media Player screen on display, use the arrow keys on the patient remote /pillow speaker to select the USB DISK and press **Enter/OK**.
3. Within each USB media directory, use the arrow keys on the patient remote/pillow speaker to scroll through available files or to navigate from one folder or file to another. Press **Enter/OK** to open or play a selected folder or file.  
**Note:** To exit the Media Player, press ↵ (patient remote) or **Return** (pillow speaker), or select/highlight the **ⓧ** button at the top right of the screen and press **Enter/OK**.

# Reference: Pillow Speaker Setup

The pillow speaker will only be functional after the Hospital Setup Wizard/Custom Master TV Setup and/or cloning/USB configuration procedures are complete.

**Note:** When Installer Menu item 027 HOSPITAL MODE is set to 254 (factory default value), there is no power (voltage) supplied to the pillow speaker interface. See also item 027 description on page 68 for further information.

## Connecting a Pillow Speaker to the TV

Connect the pillow speaker (see example at right) to the PILLOW SPEAKER interface connector on the rear jack panel of the TV.

**Caution:** Use a pillow speaker that is a UL recognized pendant control bearing the warning: “Risk of fire if used in oxygen enriched atmosphere. Keep pendant control away from oxygen equipment.”

## Controlling the TV with Serial Data

These TV models are capable of being controlled by a single-wire, serial data signal. This is an LG patented technology and is being implemented by certain brands of “smart” pillow speakers.

## Pillow Speaker Interface

This connector provides an interface for patient-pendant remote control or entertainment audio and nurse call systems. All lines are isolated from the AC power line and earth ground (a transformer isolates the DC supply, optocouplers isolate the control lines, and a transformer isolates the audio). For positive voltage configurations (e.g., for Zenith/Philips pillow speakers), +12 volts/+5 volts is provided on pin 3 (Channel Up/Data In) in reference to pin 4 (Common). For negative voltage configurations (e.g., for RCA pillow speakers), +5 volts is provided on pin 4 in reference to pin 3.

The following table describes the TV pillow speaker interface pinout. See also diagram at right.

Pin No.	Description
1	Analog external control for TV ON/OFF.
2	No connection.
3	Analog external control for Channel Up or Serial Data In.
4	Common connection for control, data, and audio output.
5	Isolated Audio Output. Nominal 14 ohm source impedance with short circuit protection. Audio level control provided by an external low-impedance, pad-type volume control or serial data Volume Up/Down keys.
6	Analog external control for Channel Down.

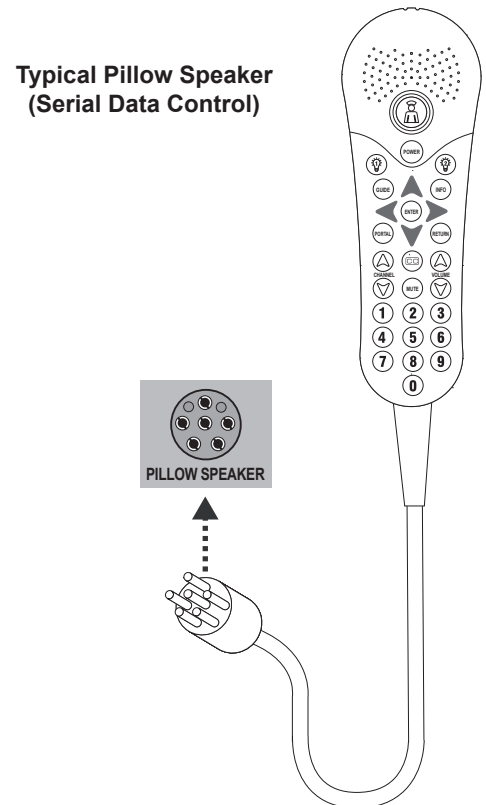

## TV Pillow Speaker Interface Pinout

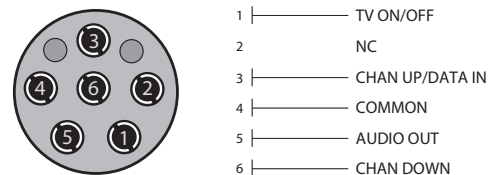

## Reference: Pillow Speaker Setup (Cont.)

### Controlling the TV with Mechanical Switches

A typical analog pillow speaker with mechanical switches will momentarily connect pin 1, 3, or 6 to pin 4 (Common) to control Power ON/OFF, Channel Up, or Channel Down. See schematic below. These pins are at +13 volts DC (when measured from pin 4) with the switches open. Typical current draw is 8 mA when a switch is closed. (This operation is identical to previous models using the 5-wire interface, except that only +7 volts DC was supplied and current draw was only 2.5 mA.)

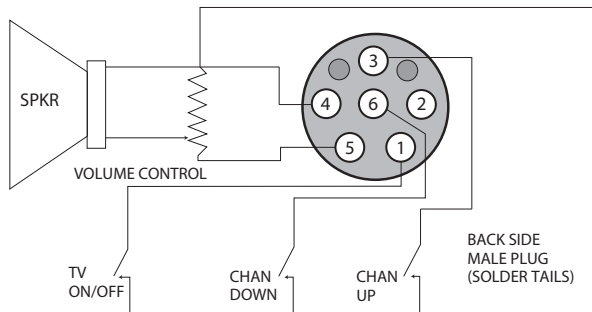

Typical Schematic for Analog  
Pillow Speaker



## Reference: VESA Standard TV Mounts

---

### General Guidelines: Choosing a Location for Installing a VESA Standard Mount

To the right are some examples of VESA standard mounts. Since there are numerous types of stands and mounts available, only a few are shown here. Refer to the instructions provided with the TV stand that will be used to mount the TV. Be sure the style of stand selected is capable of supporting the weight of the TV and is appropriate for the application.

### Wall Mounts

If the mount will be on a wall, a typical wooden stud behind the wall board would be the preferred choice for a location to attach the wall mount. The wall mount location chosen should be appropriate for drilling holes and have available the required power source as well as antenna/cable and any other equipment leads as necessary.

### Pedestal Mounts and Stands

A sturdy surface on a desk or other similar flat table-like furniture would be the appropriate location for mounting a pedestal-style TV stand.

Most stands are designed so that the wiring is threaded through the stand itself or a loop-through style clamp so that the wiring is neatly bunched and not strung in such a way as to create a potential hazard to the user. (Some stands are portable and can be moved from one location to another.) Be sure all safety considerations are followed.

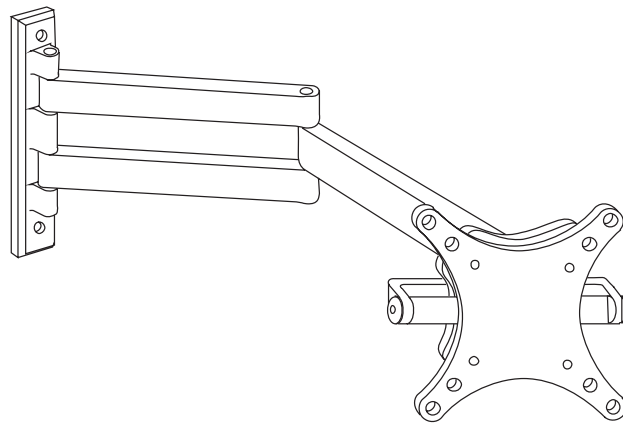

Typical Wall Stud Type Mount with Swivel Bracket

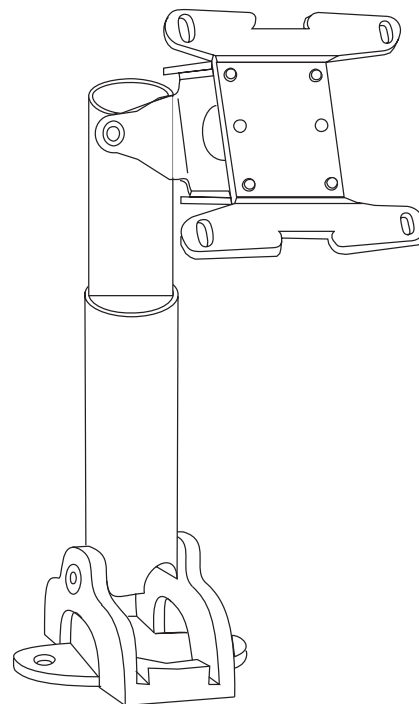

Typical Pedestal Type Mount with Swivel Bracket

# Reference: TLT Communication Parameters

Based on the setting of Installer Menu item 030 EXTCTL/ACKMASK, you may use the TV's RS-232C port for TLT communication purposes. See also "RS-232C (Control) Jack Configuration" below.

## RS-232C (Control) Jack Configuration

**CONTROL & SERVICE**  
3.5 mm Jack on TV

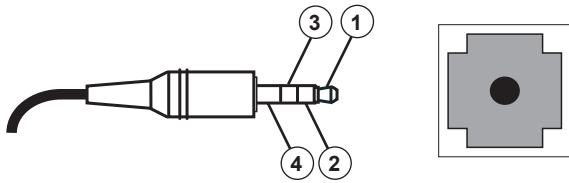

**RS-232 (Control) Jack**  
4 Contact Configuration

Contact	Description
TXD	Connects to 1 (Tip)
RXD	Connects to 2 (Ring 1)
IR Data Pass-through *	Connects to 3 (Ring 2)
GND	Connects to 4 (Sleeve)

\* Normally low signal with logic high pulses.

## Communication Parameters

- Baud rate: 9600 bps (UART)
- Parity: None
- Data length: 8 bits
- Stop bit: 1 bit

## Command Reference List

**Note:** Commands may work differently depending on model and signal.

		Command 1	Command 2	Data (Hexadecimal)		Command 1	Command 2	Data (Hexadecimal)	
01.	Power	k	a	00 / 01	11.	OSD Select	k	l	00 / 01
02.	Aspect Ratio	k	c	(see page 147)	12.	Remote Control Lock Mode	k	m	00 / 01
03.	Screen Mute	k	d	00, 01, 10	13.	Balance **	k	t	00–64
04.	Volume Mute	k	e	00 / 01	14.	Color Temperature *	x	u	00–64
05.	Volume Control	k	f	00–64	15.	Equalizer	j	v	(see page 149)
06.	Contrast *	k	g	00–64	16.	Tune Command	m	a	(see page 149)
07.	Brightness *	k	h	00–64	17.	Channel Add/Delete	m	b	00 / 01
08.	Color *	k	i	00–64	18.	Key	m	c	(see page 150)
09.	Tint *	k	j	00–64	19.	Control Backlight	m	g	00–64
10.	Sharpness *	k	k	00–32	20.	Input Select (Main)	x	b	(see page 150)

\* These features are also adjustable in the Picture Menu.

\*\* This feature is also adjustable in the Sound Menu.

## Reference: TLT Communication Parameters (Cont.)

---

### Transmitting / Receiving Protocol

This communication protocol transmits and receives 1-byte ASCII data representation for each Command, Set ID, and Data character. Therefore, a standard ASCII terminal program can be used to send and receive the protocol.

### Command Structure

[Command1][Command2][ ][Set ID][ ][Data][CR]

The following table describes the parameters.

---

[Command 1]	First part of command to control the TV: j, k, m, or x. Corresponding transmission data of 0x6A, 0x6B, 0x6D, or 0x78, respectively.
[Command 2]	Second part of command to control the TV.
[Set ID]	Choose the [Set ID] value to match the Set ID number in the General Menu. The Set ID valid range is decimal 1 to 99. If the [Set ID] value is sent as [00], every connected display will act on the command.  <b>Note:</b> The [Set ID] value should be entered in an ASCII terminal program as hexadecimal 00 to 63 values; however, note that each character of the hexadecimal value is transmitted as the ASCII value of that character.  For example: [00] since ASCII 0=0x30, would be sent as "3030" [0A] since ASCII A=0x41, would be sent as "3041" [63] since ASCII 6=0x36 & ASCII 3=0x33, would be sent as "3633"
[Data]	Enter the command's required data (hexadecimal—see [Set ID] note above for correct translation). Enter Data [FF] to read status of the function.
[CR]	Carriage Return (ASCII value 0x0D)
[ ]	Space (ASCII value 0x20)

---

### OK Acknowledgment

[Command2][ ][Set ID][ ][OK][Data][x]

The display responds with OK acknowledgment in the format shown above after receiving valid Command and Data values. The lowercase [Data] value in the response is either the current status (if Data [FF] was sent) or the [Data] value, regardless of case, that was sent in the acknowledged control command.

### Error Acknowledgment

[Command2][ ][Set ID][ ][NG][Data][x]

The display responds with NG (error) acknowledgment in the format shown above after receiving abnormal data from non-viable functions or communication errors. The lowercase [Data] value in the response is the [Data] value, regardless of case, that was sent in the acknowledged control command.

# Reference: TLT Communication Parameters (Cont.)

## Data Conversion (Hexadecimal : Decimal)

In cases where decimal values are shown in commands, refer to following conversion examples to enter the [Data] value in the terminal program as hexadecimal.

**Note:** The Channel Tune (ma) Command uses two-byte hexadecimal values ([Data]) to represent the channel number.

00: Step 0	32: Step 50 or Set ID 50	FE: Step 254
01: Step 1 or Set ID 1	33: Step 51 or Set ID 51	FF: Step 255
...	...	...
0A: Step 10 or Set ID 10	63: Step 99 or Set ID 99	01 00: Channel 256
...	...	...
0F: Step 15 or Set ID 15	C7: Step 199	27 0E: Channel 9998
10: Step 16 or Set ID 16	C8: Step 200	27 0F: Channel 9999
...	...	...

## TLT Command Detailed Descriptions

**Note:** Commands may work differently depending on model and signal.

### 01. Power (Command: k a)

- To control TV power (ON/OFF).

#### Command (Control) Structure

```
[k][a][ ][Set ID][ ][Data][CR]
```

[Data] Values:

00: Power Off  
01: Power On

#### Acknowledgment

```
[a][ ][Set ID][ ][OK/NG][Data][x]
```

- To show TV power status (ON/OFF).

#### Command (Status) Structure\*

```
[k][a][ ][Set ID][ ][FF][Cr]
```

#### Acknowledgment

```
[a][ ][Set ID][ ][OK][Data][x]
```

\* Similarly, when Data [FF] is sent for other functions (based on this format), the Acknowledgment feedback returns status about each function.

### 02. Aspect Ratio (Command: k c)

To adjust the aspect ratio.

#### Command Structure

```
[k][c][ ][Set ID][ ][Data][CR]
```

[Data] Values:

01: Normal Screen (4:3)  
02: Wide Screen(16:9)

### 04: Zoom

06: Set by Program/Original  
09: Just Scan  
10 to 1F: Cinema Zoom 1 to 16  
0C: Cinemascope (21:9)

#### Acknowledgment

```
[c][ ][Set ID][ ][OK/NG][Data][x]
```

- Using the PC input, you can select either 16:9 or 4:3 screen aspect ratio.
- In DTV/HDMI/Component mode (high-definition), Just Scan is available.
- Full wide mode may work differently based on model and is supported for DTV fully and ATV / AV partially.

### 03. Screen Mute (Command: k d)

To control screen mute.

#### Command Structure

```
[k][d][ ][Set ID][ ][Data][CR]
```

[Data] Values:

00: Screen Mute Off (Picture On)  
Video Mute Off  
01: Screen Mute On (Picture Off)  
10: Video Mute On\*

#### Acknowledgment

```
[d][ ][Set ID][ ][OK/NG][Data][x]
```

\* In case of Video Mute On only, the TV will show OSD. In case of Screen Mute On, the TV will not show OSD.

## Reference: TLT Communication Parameters (Cont.)

---

### 04. Volume Mute (Command: k e)

To control volume mute.

#### Command Structure

```
[k][e][ ][Set ID][ ][Data][CR]
```

[Data] Values:

00: Volume Mute On (Volume Off)

01: Volume Mute Off (Volume On)

#### Acknowledgment

```
[e][ ][Set ID][ ][OK/NG][Data][x]
```

### 05. Volume Control (Command: k f)

To adjust volume.

#### Command Structure

```
[k][f][ ][Set ID][ ][Data][CR]
```

[Data] Values:

00 (minimum) to 64 (maximum)

#### Acknowledgment

```
[f][ ][Set ID][ ][OK/NG][Data][x]
```

### 06. Contrast (Command: k g)

To adjust screen contrast.

#### Command Structure

```
[k][g][ ][Set ID][ ][Data][CR]
```

[Data] Values:

00 (minimum) to 64 (maximum)

#### Acknowledgment

```
[g][ ][Set ID][ ][OK/NG][Data][x]
```

### 07. Brightness (Command: k h)

To adjust screen brightness.

#### Command Structure

```
[k][h][ ][Set ID][ ][Data][CR]
```

[Data] Values:

00 (minimum) to 64 (maximum)

#### Acknowledgment

```
[h][ ][Set ID][ ][OK/NG][Data][x]
```

### 08. Color (Command: k i)

To adjust the screen color.

#### Command Structure

```
[k][i][ ][Set ID][ ][Data][CR]
```

[Data] Values:

00 (minimum) to 64 (maximum)

#### Acknowledgment

```
[i][ ][Set ID][ ][OK/NG][Data][x]
```

### 09. Tint (Command: k j)

To adjust the screen tint.

#### Command Structure

```
[k][j][ ][Set ID][ ][Data][CR]
```

[Data] Values:

00 (Red) to 64 (Green)

#### Acknowledgment

```
[j][ ][Set ID][ ][OK/NG][Data][x]
```

### 10. Sharpness (Command: k k)

To adjust the screen sharpness.

#### Command Structure

```
[k][k][ ][Set ID][ ][Data][CR]
```

[Data] Values:

00 (minimum) to 32 (maximum)

#### Acknowledgment

```
[k][ ][Set ID][ ][OK/NG][Data][x]
```

### 11. OSD Select (Command: k l)

To select OSD (On Screen Display) status when controlling remotely.

#### Command Structure

```
[k][l][ ][Set ID][ ][Data][CR]
```

[Data] Values:

00: OSD Off

01: OSD On

#### Acknowledgment

```
[l][ ][Set ID][ ][OK/NG][Data][x]
```

### 12. Remote Control Lock Mode (Command: k m)

To lock both the display panel button functions and remote control IR features.

#### Command Structure

```
[k][m][ ][Set ID][ ][Data][CR]
```

[Data] Values:

00: Lock Off

01: Lock On

# Reference: TLT Communication Parameters (Cont.)

## Acknowledgment

[m][ ][Set ID][ ][OK/NG][Data][x]

- If the TV is turned OFF by Off timer or “ka” or “mc” command) while Remote Control Lock Mode is on, it is not possible to turn the TV back ON via the POWER key on the display panel or the remote control.
- When the TV’s AC power is removed/disconnected and then reapplied, Remote Control Lock is released.

### 13. Balance (Command: k t)

To adjust sound balance.

#### Command Structure

[k][t][ ][Set ID][ ][Data][CR]

[Data] Values:

00 (minimum) to 64 (maximum)

#### Acknowledgment

[t][ ][Set ID][ ][OK/NG][Data][x]

### 14. Color Temperature (Command: x u)

To adjust color temperature.

#### Command Structure

[x][u][ ][Set ID][ ][Data][CR]

[Data] Values:

00 (minimum) to 64 (maximum)

#### Acknowledgment

[u][ ][Set ID][ ][OK/NG][Data][x]

### 15. Equalizer (Command: j v)

To adjust EQ of the TV.

#### Command Structure

[j][v][ ][Set ID][ ][Data][CR]

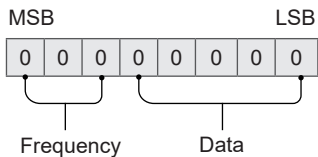

7	6	5	Frequency	4	3	2	1	0	Step
0	0	0	1st Band	0	0	0	0	0	0 (decimal)
0	0	1	2nd Band	0	0	0	0	1	1 (decimal)
0	1	0	3rd Band	-	-	-	-	-	-
0	1	1	4th Band	1	0	0	1	1	19 (decimal)
1	0	0	5th Band	1	0	1	0	0	20 (decimal)

## Acknowledgment

[v][ ][Set ID][ ][OK/NG][Data][x]

Depends on model and can be adjusted when sound mode is EQ adjustable value.

### 16. Tune Command (Command: m a)

To tune the channel to the following Physical Major/Minor Channel number.

#### Command Structure

[m][a][ ][Set ID][ ][Data0][ ][Data1]  
[ ][Data2][ ][Data3][ ][Data4][ ][Data5][CR]

- Analog Antenna/Cable

[Data0]: Physical Channel number

- Antenna (ATV): 02–45 (Decimal: 2–69)

- Cable (CATV): 01–7D (Decimal: 1–125)

[Data1–4]: Major/Minor Channel number

- Data1 & Data2: xx (Don’t care)

- Data3 & Data4: xx (Don’t care)

[Data5]: Input Source (Analog)\*

- 00: Antenna (ATV)

- 01: Cable (CATV)

\* Installer Menu items 003 BAND/AFC and 102 ATSC BAND select the tuning band(s) for the display. In order for the tune command to be executed, the Input Source value for Data5 must match each tuner’s tuning band setting.

- Digital Antenna/Cable

[Data0]: Physical Channel number\*\*

- Antenna (DTV): 02–45 (Decimal: 2–69)

- Cable (CADTV): 01–87 (Decimal: 1–135)

\*\* When [Data5] is 22, 26, or 66 (see below), use 00 for [Data0].

[Data1][Data2]: Major Channel number

- Data1: High byte Channel Data

- Data2: Low byte Channel Data

# Reference: TLT Communication Parameters (Cont.)

00 01–27 0F (Decimal: 1–9999)

[Data3][Data4]: Minor Channel number

- Data3: High byte channel data
  - Data4: Low byte channel data
- 00 00–03 E7 (Decimal: 0–999)

[Data5]: Input Source (Digital)†

- 02: Antenna (DTV), Use Physical Channel number
- 06: Cable (Auto††) (CADTV), Use Physical Channel number
- 22: Antenna (DTV), Do not use Physical Channel number (see also [Data0] \*\* above)
- 26: Cable (Auto††) (CADTV), Do not use Physical Channel number (see also [Data0] \*\* above)
- 46: Cable (Auto††) (CADTV), Use Physical Major Channel number only (One Part Channel)
- 66: Cable (Auto††) (CADTV), Use Major Channel number only (One Part Channel), Do not use Physical Channel number (see also [Data0] \*\* above)

† Installer Menu items 003 BAND/AFC and 102 ATSC BAND select the tuning band(s) for the display. In order for the tune command to be executed, the Input Source value for Data5 must match each tuner's tuning band setting.

†† Cable bands Cable Std - x3, Cable HRC - x4, and Cable IRC - x5 can also be used in [Data5] lower nibble.

Two bytes are available for each Major and Minor Channel number. The high byte is 00 unless the channel number exceeds 255.

### Tune Command Examples:

#### Example 1: Tune to analog cable channel 35

Set ID = All = 00  
 Data0 = Channel Data is 35 = 23  
 Data1 & Data2 = No Major = 00 00  
 Data3 & Data4 = No Minor = 00 00  
 Data5 = Analog Cable = 01  
 Total = ma 00 23 00 00 00 00 01

#### Example 2: Tune to digital antenna channel 30-3

Set ID = All = 00  
 Data0 = Don't know Physical = 00  
 Data1 & Data2 = Major is 30 = 00 1E  
 Data3 & Data4 = Minor is 3 = 00 03  
 Data5 = Digital Antenna = 22  
 Total = ma 00 00 00 1E 00 03 22

### Acknowledgment

```
[a][ ][Set ID][ ][OK][Data 0][Data1]
[Data2][Data3][Data4][Data5][x]
[a][ ][Set ID][ ][NG][Data0][x]
```

### 17. Channel Add/Delete (NTSC) (Command: m b)

To set the saved channel status.

### Command Structure

```
[m][b][ ][Set ID][ ][Data][CR]
```

[Data] Values:

- 00: Delete
- 01: Add

### Acknowledgment

```
[b][ ][Set ID][ ][OK/NG][Data][x]
```

### 18. Key (Command: m c)

To send IR remote key code.

### Command Structure

```
[m][c][ ][Set ID][ ][Data][CR]
```

See Key Codes table on page 151 for [Data] values.

### Acknowledgment

```
[c][ ][Set ID][ ][OK/NG][Data][x]
```

### 19. Control Backlight (Command: m g)

To control the backlight.

### Command Structure

```
[m][g][ ][Set ID][ ][Data][CR]
```

[Data] Values:

- 00 (minimum) to 64 (maximum)

### Acknowledgment

```
[g][ ][Set ID][ ][OK/NG][Data][x]
```

### 20. Input select (Command: x b)

To select input source for main picture.\*

### Command Structure

```
[x][b][ ][Set ID][ ][Data][CR]
```

[Data] Values:

- |                   |                 |
|-------------------|-----------------|
| 00: DTV           | 41: Component 2 |
| 01: CADTV         | 60: RGB         |
| 02: Satellite DTV | 90: HDMI 1      |
| 10: ATV           | 91: HDMI 2      |
| 11: CATV          | 92: HDMI 3      |
| 20: AV or AV 1    | 93: HDMI 4      |
| 21: AV 2          |                 |
| 40: Component 1   |                 |

### Acknowledgment

```
[b][ ][Set ID][ ][OK/NG][Data][x]
```









\* This function depends on model and signal.



## Reference: TLT Communication Parameters (Cont.)

### Key Codes

The following table provides typical LG key codes. Some keys are not applicable to all models.

Code (Hexa)	Function	Code (Hexa)	Function
00	CH UP	C0	 (Green)
01	CH DOWN	C1	 (Red)
02	VOL UP	C2	 (Yellow)
03	VOL DOWN	C3	 (Blue)
06	> (Right Arrow)	8E	 (Fast Forward)
07	< (Left Arrow)	8F	 (Rewind)
40	^ (Up Arrow)	B0	 (Play)
41	v (Down Arrow)	B1	 (Stop)
08	POWER (toggle)	BA	 (Pause)
C4	POWER ON	AA	INFO
C5	POWER OFF	AB	GUIDE
09	MUTE	7C	SMART
10–19	Numbers (0–9)	7E	SIMPLINK
28	BACK	DC	3D
39	CC (Closed Caption)	60	PIP
43	MENU SETTINGS	61	PIP INPUT
44	OK/ENTER	63	PIP SWAP
0A	SAP	71	PIP CH UP
0B	INPUT	72	PIP CH DOWN
0C	PORTAL	79	ASPECT RATIO
0E	TIMER	91	VIDEO DESCRIPTION
1A	FLASHBACK	CE	HDMI 1
4C	DASH	CC	HDMI 2
5B	EXIT	E9	HDMI 3
D6	TV	DA	HDMI 4
5A	VIDEO 1	BF	COMPONENT 1
D0	VIDEO 2	D4	COMPONENT 2
D5	RGB		

# Troubleshooting

## General Troubleshooting

Some Quick and Easy Tips for Resolving Problems

### Installation

Symptom	Possible Cause(s)	Possible Solution(s)
Cannot direct enter channel number.	(TV in Pass-through Mode) Installer Menu item 028 CH. OVERRIDE is set to 0, i.e., disabled (recommended setting).	If Installer Menu item 028 CH. OVERRIDE is set to 0, only channels that are active in the TV's channel lineup can be selected. Set CH. OVERRIDE to 1 to allow access for direct keypad entry to all channels.
	(TV not in Pass-through Mode) The channel entered is not included in the applicable Channel Map.	Channel access is restricted to channels included in the applicable Channel Map, for example the FTG Channel Map if the TV is in FTG Mode or the Pro:Centric Direct Channel Map if the TV is in Application Tuning Mode with Pro:Centric Direct. If necessary, make changes to the Channel Map using the appropriate application/content editor.
No channels present after Hospital Setup Wizard is finished.	Channel Tuning not run, no channels manually added, and/or no Aux inputs enabled.	Refer to Hospital Setup Wizard procedure. To reactivate the Hospital Setup Wizard, restore the TV to a factory default condition.

### Picture Reception and Sound

Symptom	Possible Cause(s)	Possible Solution(s)
No picture.	TV is turned OFF.	<ul style="list-style-type: none"> <li>• Turn TV ON.</li> <li>• Power failure?</li> </ul>
	Antenna/cable not connected.	Connect antenna/cable signal to TV.
	Connections incorrect.	Check connections on TV.
	MPI not connected.	If applicable, connect MPI cable to MPI device.
	Encrypted program.	Try another channel.
	Wrong tuning band.	Adjust Installer Menu settings.
Normal picture, poor or no sound.	Audio muted.	Press MUTE or use Volume Up key to increase sound level.
	Broadcast problem.	Try a different channel.
	Pillow/TV speaker not configured properly.	Check that Installer Menu items 020 FEATURE LEVEL and 027 HOSPITAL MODE are set as required. Also, if applicable, select TV Speaker in the Sound Out Menu.

### Erratic Operation

Symptom	Possible Cause(s)	Possible Solution(s)
Installer Menu setup.	Wrong Installer Menu settings.	Adjust Installer Menu settings as required.

## General Troubleshooting (Cont.)

### Installer Remote

Symptom	Possible Cause(s)	Possible Solution(s)
Remote doesn't work.	Remote not in TV Mode.	Depending on the remote used, you may need to use a MODE key to put the remote into TV Mode.
	Not aimed at IR receiver.	Point remote at IR receiver on TV.
	Remote too far from IR receiver or IR path is obstructed.	Move remote closer to IR receiver on TV, darken room, and/or remove obstructions.
	MPI not connected.	If applicable, connect MPI cable to MPI device.
	Weak batteries.	Replace batteries.
	Wrong battery polarity.	Check that "+" and "-" match in battery compartment.
	Too much light in room.	Dim room light.
	Remote IR codes do not match setting(s) in TV.	Make sure the Installer Remote is compatible. Contact your LG service representative, as necessary. Then, check settings both in the TV and on the remote. IR codes sent by the remote must match the setting(s) in the TV.

## Commercial Mode Check

Use this flowchart to determine whether the TV is currently in Commercial Mode.

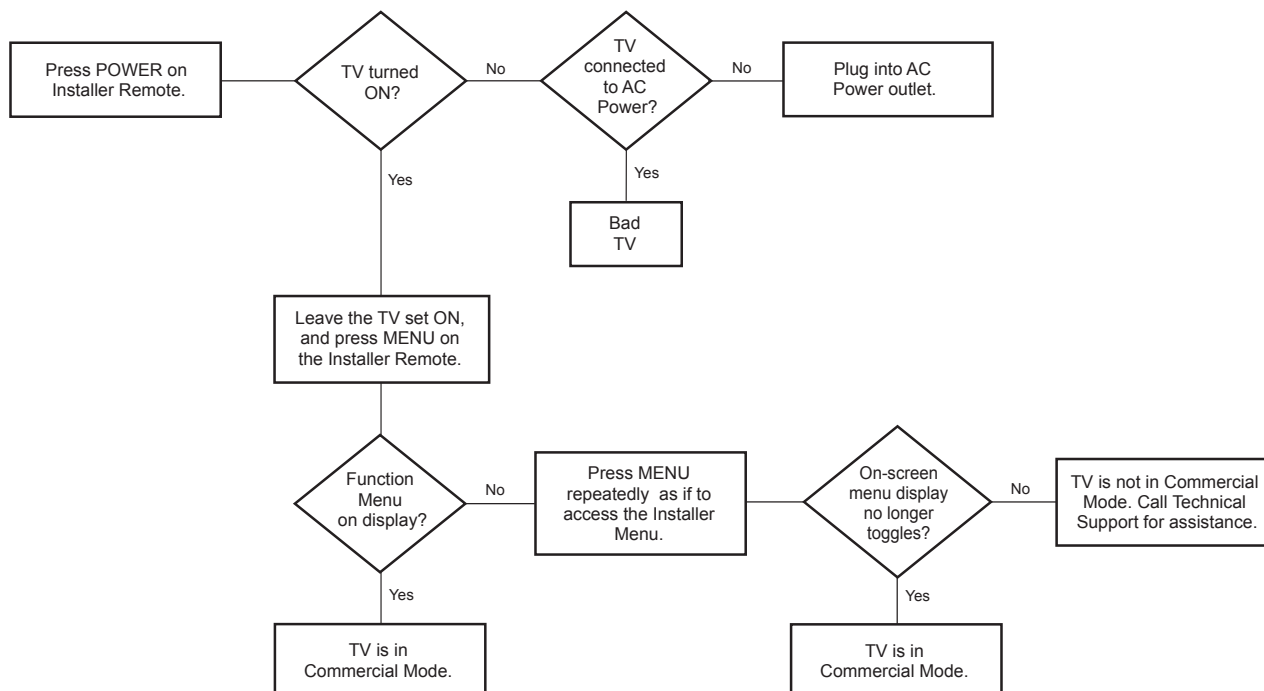

## Troubleshooting (Cont.)

### FTG Operation Troubleshooting

The following table provides troubleshooting information for when the EBL is configured for FTG Mode operation.

Symptom	Possible Cause(s)	Possible Solution(s)
Communication Error ("Communications Timeout")	Cable(s) not connected.	Check and connect communication cables.
	TV not powered.	Check/connect the TV power cord.
	TV not turned ON.	TV needs to be turned ON (default setting of Installer Menu item 118 POWER SAVINGS).
	Wrong COM (communication) port.	In the FTG Device Configuration Application, select the correct COM port for the cable being used.

### Channel Banks Setup Troubleshooting

Symptom	Possible Cause(s)	Possible Solution(s)
Channel is blanked in all channel banks.	Blanking a channel in one channel bank will make it blank in all channel banks.	Modify the channel attribute(s), if desired, using the Cloud Configuration Tool / Channel Map utility. See also the Channel Map web page overview on page 90. Restore normal operation by unchecking the "Blank Video" checkbox for the channel. Note that normal operation will be restored to the channel in all channel banks.
"Inactive TV" message appears and then TV turns OFF.	TV is set up to display "Inactive TV" message if all channels are restricted from Channel Bank 4.	Use the Installer Remote to select another channel bank (1, 2, or 3) to return TV to normal operation.
Channel found during Channel Tuning does not tune in with Channel Up/Down.	Channel was restricted from currently selected channel bank.	Premium channels may only be available on another channel bank. Modify the channel bank allocation(s) for the channel, if desired, using the Cloud Configuration Tool / Channel Map utility. See also the Channel Map web page overview on page 90.
When CH BANK key on Installer Remote is pressed, TV shows Input List Menu.	Installer Menu item 027 HOSPITAL MODE is set to 0 (i.e., Hospital Mode is disabled).	Installer item 027 must be set appropriately (i.e., Hospital Mode must be enabled) in order for channel banks to be available. If the TV is in CPU-CTV or PTC-CTV Mode, access the Installer Menu and set item 027 as applicable. If the TV is in FTG Mode via CPU, use the Cloud Configuration Tool / Installer Menu utility to update Installer Menu item #27.

## Application Tuning Mode

LG commercial TV mode that enables the TV's Channel Map to reside in a Pro:Centric application.

## b-LAN

SONIFI Solutions, Inc. proprietary RF communication system used to configure/control TV via RF distribution system.

## Basic Settings Wizard

Lodging model TV configuration wizard that provides basic settings options. Includes Channel Tuning.

## Channel Lineup

Channels set in the TV memory, via Channel Tuning/manual editing.

## Channel Map

Typically refers to a logical channel mapping of physical channels (for example, an FTG Channel Map). This allows digital channels, like analog channels, to be tuned without requiring the dash key. Also, channels (analog or digital) can be arranged in any order that seems logical for customer tuning/viewing.

## Cloning

The process of capturing a Master TV Setup and transferring it to a Target TV using a USB memory device.

## Commercial Mode

A mode of operation that provides a broad range of commercial TV features based on control (settings) provided by the PTC and/or an MPI control device.

## CPU

The TV's Central Processing Unit. Responsible for the presentation of video and audio from content received via the TV's tuner or Aux inputs.

## EBL

Embedded b-LAN module. See also b-LAN.

## E-Z Installation

Enables boot logo image, TV configuration, and software file downloads to selected TV models from a Pro:Centric server. Managed and administered via the appropriate Pro:Centric Admin Client.

## EZ-Manager Wizard

Lodging/hospital model TV configuration wizard that provides configuration options for Pro:Centric operation as well as an option for using a USB memory device to configure a TV.

## FTG Mode

LG commercial TV mode that enables decryption of Pro:Idiom encrypted channels and logical channel mapping. Implementation and TV operation is based on the "owner" of the FTG Channel Map—the CPU or the EBL. TVs may be configured locally using LG's proprietary applications or remotely using an applicable head end device.

## Function Menu

Available via Installer Remote "MENU" key. Indicates the TV is not in Pass-through Mode. Restricts menu options to a subset of the TV setup menus, allowing users to retain functional control, while disabling setup options.

## Hospital Setup Wizard

Hospital model TV configuration wizard that provides streamlined configuration for FTG Mode via CPU operation in a hospital setting, including a configuration option for Pro:Centric operation.

## Installer Menu

Defines commercial TV functionality based on the parameters set.

## LG Free-To-Guest (FTG)

Refers to a particular commercial mode of operation within an LG TV. See also FTG Mode.

## Logical Channel Number

A number assigned to either a physical or virtual channel number in a Logical Channel Map.

## Major Channel Number

Typically, the RF channel number assigned to a digital video stream.

## Master TV

A TV whose Channel Map and Installer Menu and TV setup menu settings have been configured as a Master TV Setup for cloning purposes.

## Minor Channel Number

A sub-channel or program number assigned to the content embedded in the digital video stream.

## MPI

Multiple Protocol Interface. An MPI port or, for some TV models, an MPI card slot provides external control options for solution providers.

## Pass-through Mode

The TV's factory default mode of operation. TVs can be configured for stand-alone use or

as Master TVs for cloning purposes, and/or TVs may be controlled externally in this mode.

## Physical Channel Number

The major channel number assigned to represent a specific 6 MHz RF band as specified by either the broadcast or CATV channel plan. See CEA (formerly EIA) or NCTA specifications for further information.

## Pro:Centric Application

LG content delivery and communication interface powered by an on-site Pro:Centric server or a Pro:Centric Cloud server that provides interactive entertainment, weather, amenities, etc. information for end users. Two application options are available: Pro:Centric Java application (on-site server only) or Pro:Centric Direct HTML application.

## Pro:Centric Admin Client

Web editor/content wizard provided for service provider and customer configuration of Pro:Centric application and management elements. The proper Admin Client must be used in accordance with server type and licensed application.

## Pro:Idiom

Zenith proprietary security software that unlocks access to premium content to help assure rapid, broad deployment of HDTV and other high-value digital content.

## PTC

Protocol Translation Controller. The commercial controller (microprocessor) of the commercial TV.

## Target TV

A TV to which a Master TV Setup will be transferred.

## TV Setup Menus

Available via Installer Remote "MENU" key in Pass-through Mode only. Menus provide access to TV setup and functional features.

## USB Memory Device

A USB flash drive or USB storage device, etc. that can be used for TV configuration purposes (typically cloning or FTG Mode via CPU configuration) or for updating TV software.

## Virtual Channel Number

An alias (virtual) channel number provided in the data stream, by the broadcaster, of a digital broadcast channel to be displayed by consumer TVs in place of the physical channel number. The major number is the same as the original analog channel number and the minor number is the nth program available in that digital video stream.

# Document Revision History / Open Source Software Notice

---

## Document Revision History

Date	Description
September 2020	Revision A: New document
October 2020	Revision B: IP Environment Menu and TLT parameter updates
November 2020	Revision C: Hospital Setup Wizard updates
March 2021	Revision D: Hospital Setup Wizard and Installer Menu updates
June 2022	Revision E: Installer Menu, PCC, and IP Environment updates
March 2024	Revision F: External control, Installer Menu, IP Environment, and remote updates
July 2024	Revision G: Power Mgmt and TLT updates

Product documentation is available online at: [www.lg.com/us/business](http://www.lg.com/us/business).

---

## Open Source Software Notice

To obtain the source code under GPL, LGPL, MPL and other open source licenses, that is contained in this product, please visit <http://opensource.lge.com>. In addition to the source code, all referenced license terms, warranty disclaimers and copyright notices are available for download. LG Electronics will also provide open source code to you on CD-ROM for a charge covering the cost of performing such distribution (such as the cost of media, shipping and handling) upon e-mail request to [opensource@lge.com](mailto:opensource@lge.com). This offer is valid for three (3) years from the date on which you purchased the product.



---

For Customer Support/Service, please call:

**1-888-865-3026**

[www.lg.com/us/business](http://www.lg.com/us/business)

Pro:Idiom is a registered trademark of Zenith Electronics LLC. Pro:Centric, Smart Share, and the "LG" logo are registered trademarks of LG Electronics Inc. *b*-LAN is a trademark of SONIFI Solutions, Inc. DLNA Certified is a registered trademark of Digital Living Network Alliance. Intel is a registered trademark of Intel Corporation in the U.S. and/or other countries. Miracast is a registered trademark of Wi-Fi Alliance. All other trademarks or registered trademarks are the property of their respective owners.